

REV.	DESCRIPTION	DATE
A	NEW DRAWING	4/6/2006
B	Model update	10/6/2006
C	dimension change from 34.0 to 36.0mm	8/4/2008

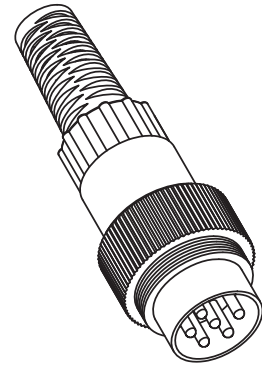

SCALE 1:1

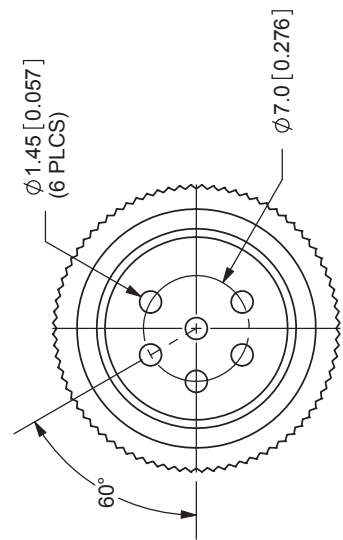
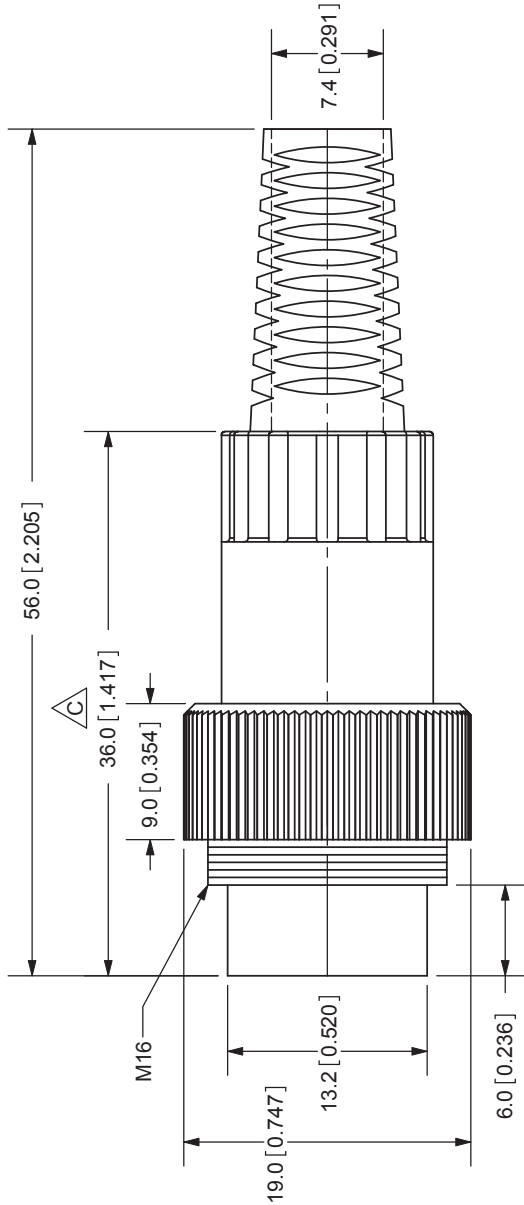

TOLERANCE:
 X.X ±0.2mm
 X.XX ±0.1mm
 X.XXX ±0.05mm



20050 SW 112th Ave.
 Tualatin, OR 97062
 Phone: 503-612-2300
 800-275-4899
 Fax: 503-612-2383
 Website: www.cui.com

TITLE: DIN PLUG, LOCKING, IN-LINE 6P	REV: C
PART NO: SD-60LP	UNITS: MM [INCHES]
DRAWN BY: ZRJ	APPROVED BY:
	SCALE: 2:1

SPECIFICATIONS:
 RATING: 100V AC @ 2A
 CONTACT RESISTANCE: 20m OHMS MAX
 INSULATION RESISTANCE: 100M OHMS MIN: 500V DC
 VOLTAGE WITHSTAND: 1000V AC R.M.S. FOR 1 MINUTE
 OPERATING TEMP: -40° ~ +85°C