

**SERIES:** PBK-3 | **DESCRIPTION:** AC-DC POWER SUPPLY

**FEATURES**

- up to 3 W continuous output
- compact SIP package
- single regulated outputs from 3.3~24 V
- 3,000 Vac isolation
- over current and short circuit protections
- CE, UL60950-1 safety approval
- wide input voltage: 100~400 Vdc (85~264 Vac)
- efficiency up to 78%

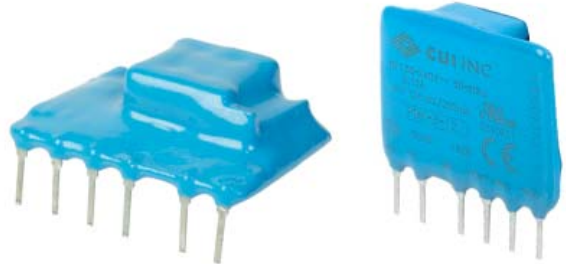

MODEL	output voltage	output current	output power	ripple and noise <sup>2</sup>	efficiency
	(Vdc)	max (mA)	max (W)	max (mVp-p)	typ (%)
PBK-3-3 <sup>1</sup>	3.3	500	1.65	150	66
PBK-3-5	5	500	2.5	150	69
PBK-3-9	9	333	3	120	76
PBK-3-12	12	250	3	120	78
PBK-3-15	15	200	3	120	78
PBK-3-24	24	125	3	120	78

Note: 1. The PBK-3-3 & PBK-3-3-B do not meet UL and CE standards.  
 2. Measured at 20 MHz bandwidth, see Test Configuration section.

**PART NUMBER KEY**

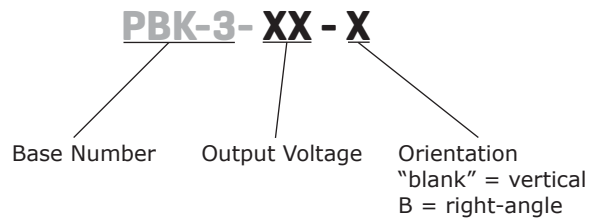

## INPUT

parameter	conditions/description	min	typ	max	units
voltage		85 100		264 400	Vac Vdc
frequency		47		440	Hz
current	at 115 Vac at 230 Vac			120 60	mA mA
inrush current	at 115 Vac at 230 Vac		20 40		A A
no load power consumption				0.5	W
input fuse	1 A/250 V, slow-blow type (external, required)				

## OUTPUT

parameter	conditions/description	min	typ	max	units
output current		10			%
capacitive load	3.3 Vdc output models 5 Vdc output models 9 Vdc output models all other models			2300 470 150 100	$\mu$ F $\mu$ F $\mu$ F $\mu$ F
line regulation	3.3 Vdc models, at full load all other models, at full load		$\pm 0.5$ $\pm 1.5$		% %
load regulation	3.3 Vdc models, at 10%~100% load all other models, at 10%~100% load		$\pm 1.5$ $\pm 2.5$		% %
voltage set accuracy	3.3 Vdc output models 9 & 12 Vdc output models all other models			$\pm 3$ $\pm 8$ $\pm 5$	% % %
hold-up time	at 115 Vac at 230 Vac	60 300			ms ms
switching frequency	3.3 Vdc output models all other models		100	50	kHz kHz
temperature coefficient			$\pm 0.15$		%/°C

## PROTECTIONS

parameter	conditions/description	min	typ	max	units
short circuit protection	continuous, auto restart				
over current protection	auto restart				

## SAFETY & COMPLIANCE

parameter	conditions/description	min	typ	max	units
isolation voltage	input to output, for 1 minute	3,000			Vac
isolation resistance		100			M $\Omega$
safety approvals	UL60950-1, CE				
safety class	Class II				
conducted emissions	CISPR22/EN55022 external circuit required, Class A (see figure 2); Class B (see figure 3)				
radiated emissions	CISPR22/EN55022 external circuit required, Class A (see figure 2); Class B (see figure 3)				
ESD	IEC/EN61000-4-2 Class B, contact $\pm 4$ kV				
radiated immunity	IEC/EN61000-4-3 Class A, 10V/m (external circuit required, see figure 3)				
EFT/burst	IEC/EN61000-4-4 Class B, $\pm 2$ kV (external circuit required, see figure 2) IEC/EN61000-4-4 Class B, $\pm 4$ kV (external circuit required, see figure 3)				
surge	IEC/EN61000-4-5 Class B, $\pm 1$ kV/ $\pm 2$ kV (external circuit required, see figure 3)				
conducted immunity	IEC/EN61000-4-6 Class A, 3 Vr.m.s (external circuit required, see figure 3)				
PFM	IEC/EN61000-4-8 Class A, 10 A/m				

## SAFETY & COMPLIANCE (CONTINUED)

parameter	conditions/description	min	typ	max	units
voltage dips & interruptions	IEC/EN61000-4-11 Class B, 0%-70%				
MTBF	at 25°C, max. load	300,000			hours
RoHS	2011/65/EU				

## ENVIRONMENTAL

parameter	conditions/description	min	typ	max	units
operating temperature	see derating curves	-40		85	°C
storage temperature		-40		105	°C
case temperature				90	°C
humidity	non-condensing			85	%

## DERATING CURVES

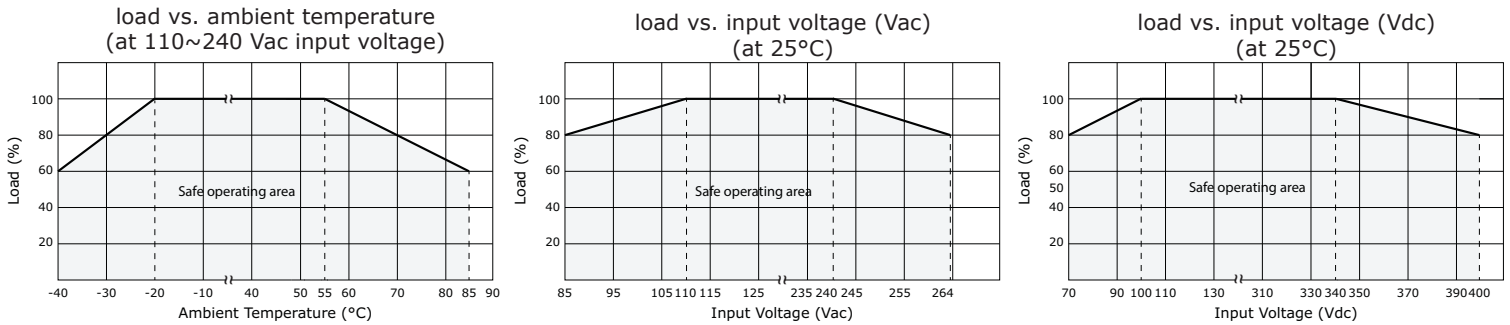

## EFFICIENCY CURVES

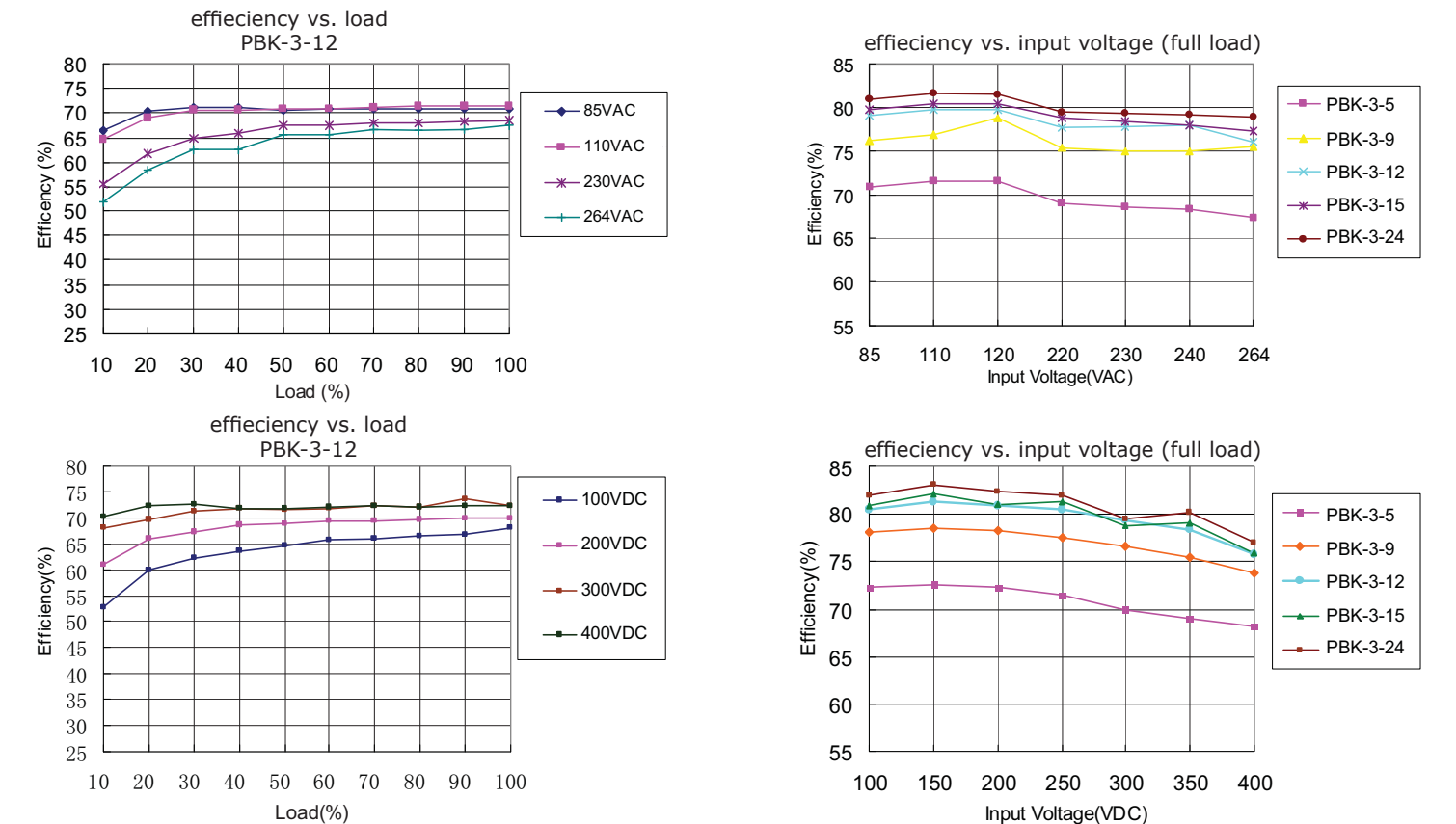

## SOLDERABILITY

parameter	conditions/description	min	typ	max	units
hand soldering	for 3~5 seconds	350	360	370	°C
wave soldering	for 5~10 seconds	255	260	265	°C

## MECHANICAL

parameter	conditions/description	min	typ	max	units
dimensions	PBK-3-3 vertical model: 37 x 11 x 25 all other vertical models: 35 x 11 x 25 PBK-3-3 right-angle model: 37 x 13 x 25 all other right-angle models: 35 x 13 x 25				mm
material	UL94V-0				
weight			8		g

## MECHANICAL DRAWING

### PBK-3-3 VERTICAL ORIENTATION

units: mm[inch]

tolerance:  $\pm 0.5[\pm 0.020]$

pin tolerance:  $\pm 0.1[\pm 0.004]$

PIN CONNECTIONS	
PIN	FUNCTION
1	-Vin (N)
3	+Vin (L)
5	+V(CAP)
7	-V(CAP)
10	-Vo
12	+Vo

Note: 1. It is required to add C1 between pins 5 & 7 (see application circuits).

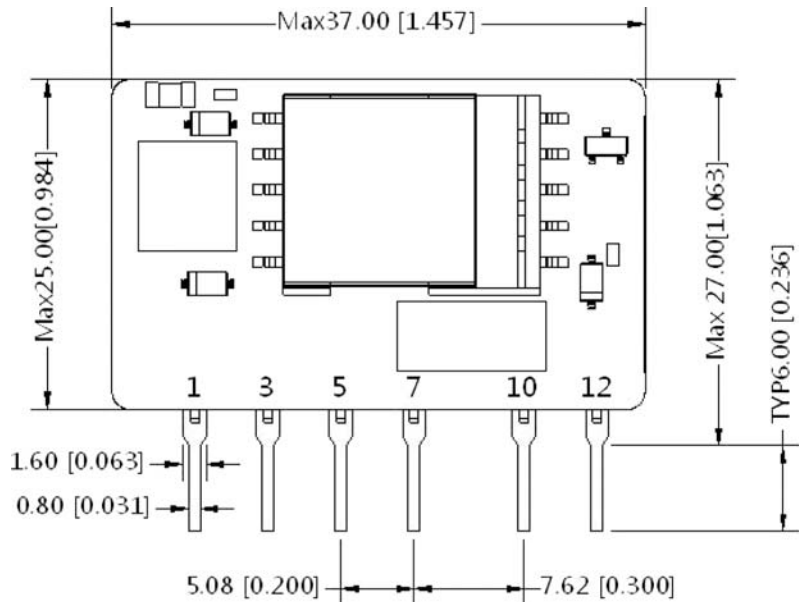

Front View

Note: Grid 2.54\*2.54mm

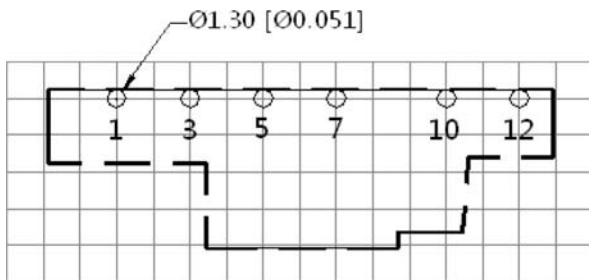

Top View  
PCB Layout

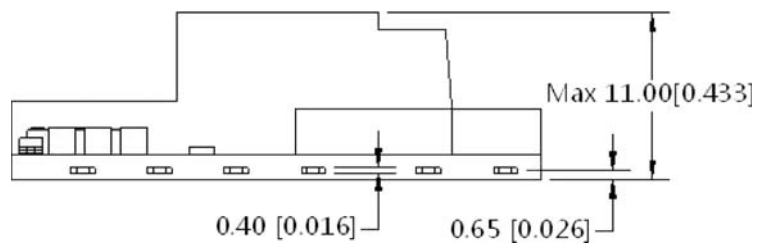

Bottom View

## MECHANICAL DRAWING (CONTINUED)

### VERTICAL ORIENTATION (ALL OTHER MODELS)

units: mm[inch]  
 tolerance:  $\pm 0.5[\pm 0.020]$   
 pin tolerance:  $\pm 0.1[\pm 0.004]$

PIN CONNECTIONS	
PIN	FUNCTION
1	-Vin (N)
3	+Vin (L)
5	+V(CAP)
7	-V(CAP)
10	-Vo
12	+Vo

Note: 1. It is required to add C1 between pins 5 & 7 (see application circuits).

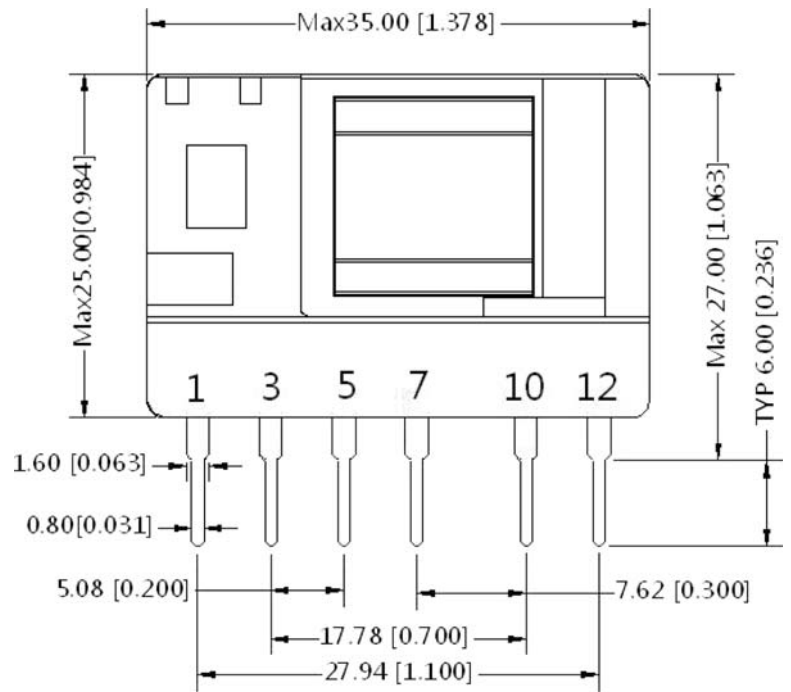

Front View

Note: Grid 2.54\*2.54mm

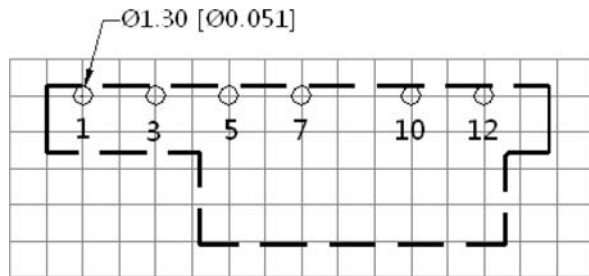

Top View  
PCB Layout

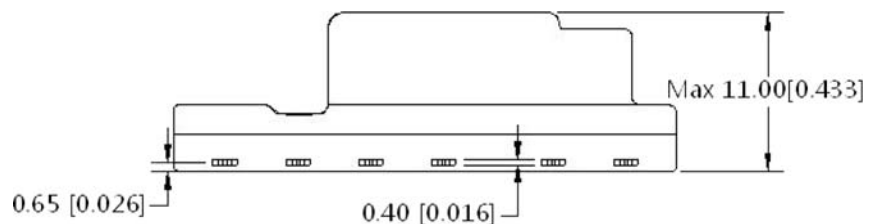

Bottom View

## MECHANICAL DRAWING (CONTINUED)

### PBK-3-3 RIGHT-ANGLE ORIENTATION

units: mm[inch]  
 tolerance:  $\pm 0.5[\pm 0.020]$   
 pin tolerance:  $\pm 0.1[\pm 0.004]$

PIN CONNECTIONS	
PIN	FUNCTION
1	-Vin (N)
3	+Vin (L)
5	+V(CAP)
7	-V(CAP)
10	-Vo
12	+Vo

Note: 1. It is required to add C1 between pins 5 & 7 (see application circuits).

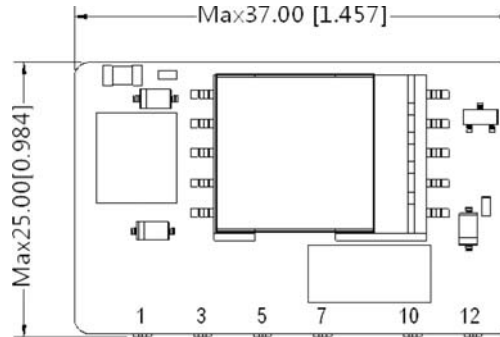

Front View

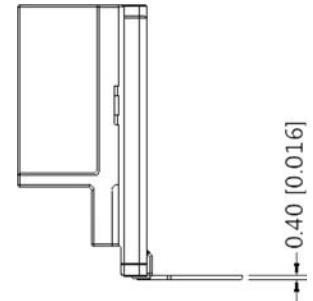

Side View

Note: Grid 2.54\*2.54mm

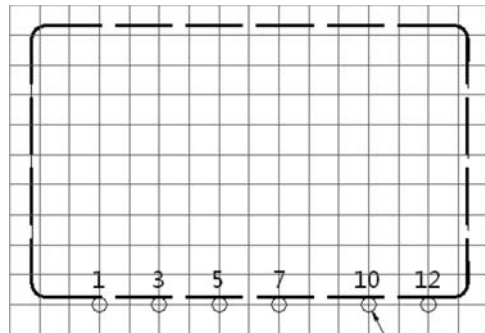

Top View  
 PCB Layout

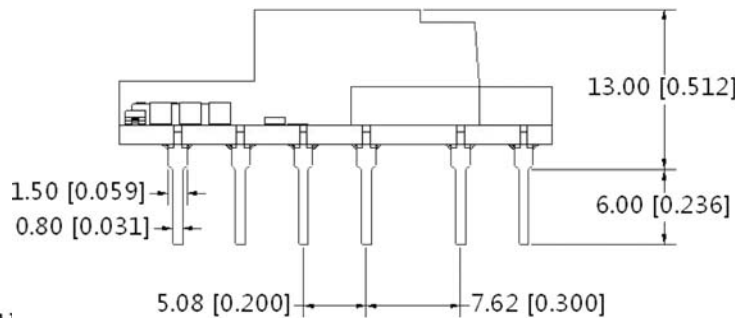

Bottom View

## MECHANICAL DRAWING (CONTINUED)

### RIGHT-ANGLE ORIENTATION (ALL OTHER MODELS)

units: mm[inch]  
 tolerance:  $\pm 0.5[\pm 0.020]$   
 pin tolerance:  $\pm 0.1[\pm 0.004]$

PIN CONNECTIONS	
PIN	FUNCTION
1	-Vin (N)
3	+Vin (L)
5	+V(CAP)
7	-V(CAP)
10	-Vo
12	+Vo

Note: 1. It is required to add C1 between pins 5 & 7 (see application circuits).

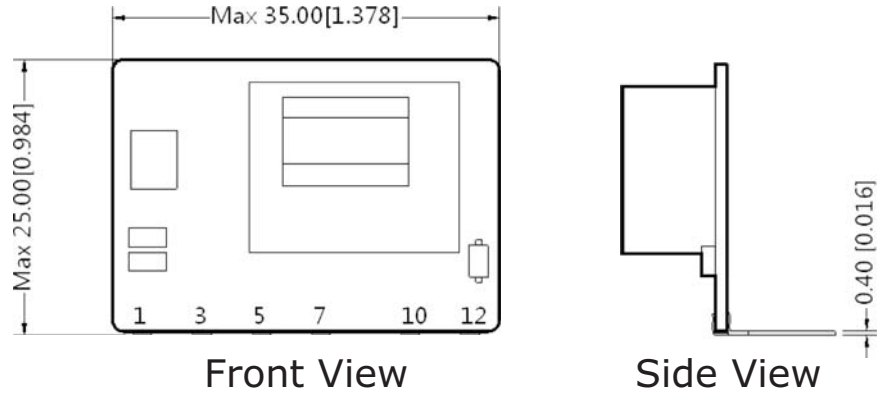

Note: Grid 2.54\*2.54mm

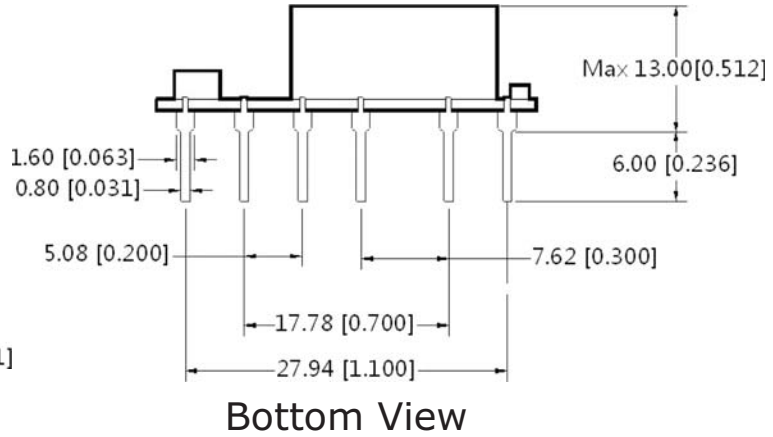
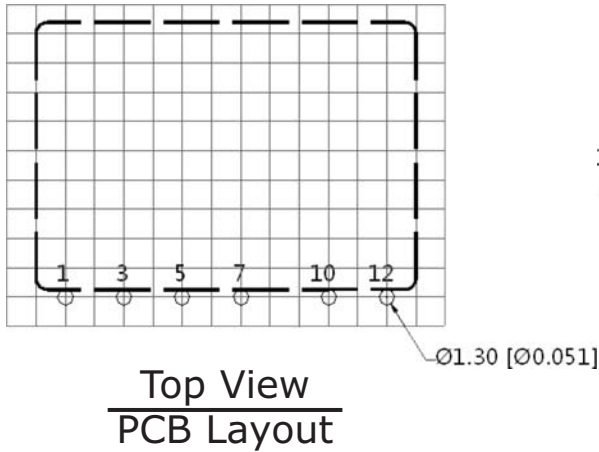

## TEST CONFIGURATION

Figure 1

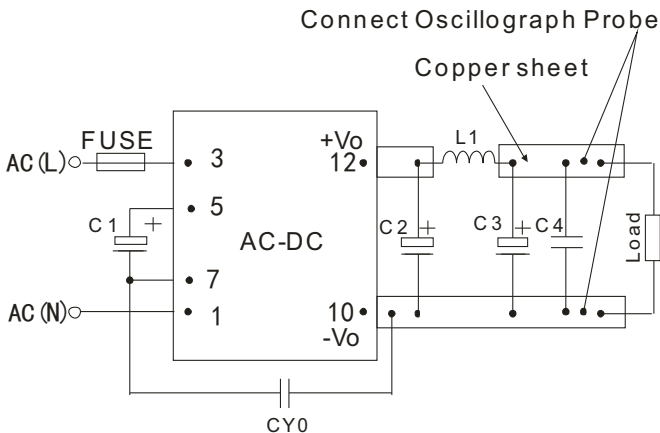

Table 1

$V_{OUT}$ (Vdc)	Recommended External Circuit Components					
	C1 <sup>1</sup>	C2 <sup>1</sup>	L1 <sup>1</sup>	C3 <sup>1</sup>	C4	CY0 (Y1 capacitor)
3.3	22 $\mu$ F/400V	330 $\mu$ F/25V	2.2 $\mu$ H	120 $\mu$ F/25V	0.1 $\mu$ F/50V	1nF/400Vac
5	22 $\mu$ F/400V	330 $\mu$ F/25V	2.2 $\mu$ H	68 $\mu$ F/35V	0.1 $\mu$ F/50V	1nF/400Vac
9	22 $\mu$ F/400V	330 $\mu$ F/25V	2.2 $\mu$ H	68 $\mu$ F/35V	0.1 $\mu$ F/50V	1nF/400Vac
12	22 $\mu$ F/400V	150 $\mu$ F/35V	2.2 $\mu$ H	68 $\mu$ F/35V	0.1 $\mu$ F/50V	1nF/400Vac
15	22 $\mu$ F/400V	150 $\mu$ F/35V	2.2 $\mu$ H	68 $\mu$ F/35V	0.1 $\mu$ F/50V	1nF/400Vac
24	22 $\mu$ F/400V	100 $\mu$ F/35V	2.2 $\mu$ H	68 $\mu$ F/35V	0.1 $\mu$ F/50V	1nF/400Vac

Note: 1. Required components.  
 2. 1 A/250 V fuse required.

## TYPICAL APPLICATION CIRCUIT

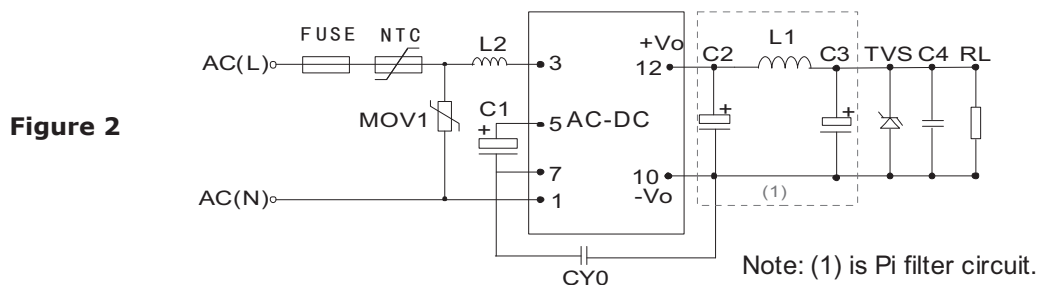

Table 2

Recommended External Circuit Components											
$V_{OUT}$ (Vdc)	C1 <sup>1</sup>	L2	C2 <sup>1</sup>	L1 <sup>1</sup>	C3 <sup>1</sup>	C4	CY0	FUSE <sup>1</sup>	TVS	NTC	MOV1
3.3	22 $\mu$ F/400V	5mH	330 $\mu$ F/25V	2.2 $\mu$ H	120 $\mu$ F/25V	0.1 $\mu$ F/50V	1nF/400Vac	1A/250V	SMBJ7.0A	5D-9	S14K350
5	22 $\mu$ F/400V	5mH	330 $\mu$ F/25V	2.2 $\mu$ H	68 $\mu$ F/35V	0.1 $\mu$ F/50V	1nF/400Vac	1A/250V	SMBJ7.0A	5D-9	S14K350
9	22 $\mu$ F/400V	5mH	330 $\mu$ F/25V	2.2 $\mu$ H	68 $\mu$ F/35V	0.1 $\mu$ F/50V	1nF/400Vac	1A/250V	SMBJ12A	5D-9	S14K350
12	22 $\mu$ F/400V	5mH	150 $\mu$ F/35V	2.2 $\mu$ H	68 $\mu$ F/35V	0.1 $\mu$ F/50V	1nF/400Vac	1A/250V	SMBJ20A	5D-9	S14K350
15	22 $\mu$ F/400V	5mH	150 $\mu$ F/35V	2.2 $\mu$ H	68 $\mu$ F/35V	0.1 $\mu$ F/50V	1nF/400Vac	1A/250V	SMBJ20A	5D-9	S14K350
24	22 $\mu$ F/400V	5mH	100 $\mu$ F/35V	2.2 $\mu$ H	68 $\mu$ F/35V	0.1 $\mu$ F/50V	1nF/400Vac	1A/250V	SMBJ30A	5D-9	S14K350

Note: 1. Required components.

## EMC RECOMMENDED CIRCUIT

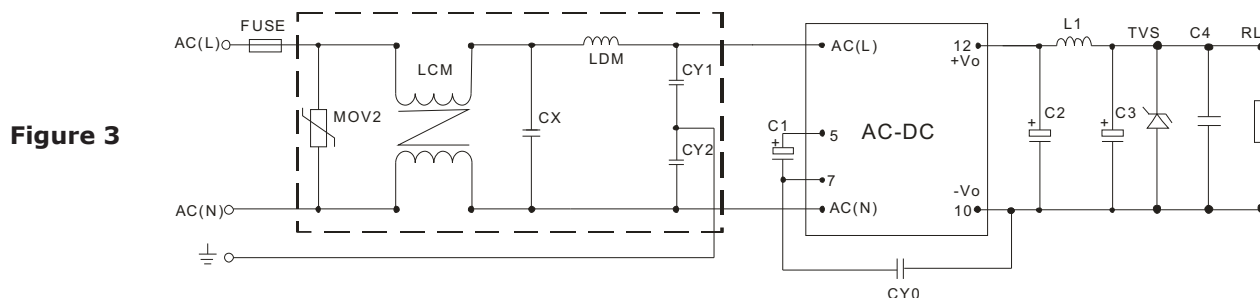

Table 3

Recommended External Circuit Components	
MOV2	S10K300
CY1, CY2	1nF/400Vac
CX	0.1 $\mu$ F/275Vac
LCM	3.5mH
LDM	5mH
FUSE	1A/250V, slow blow

Note: Also refer to Table 2.

- Notes:
- C1 and C3 are electrolytic capacitors. They are required for both AC input and DC input.
  - For AC input, C1 is used as a filter capacitor. The recommended C1 value is 22  $\mu$ F/400 V.
  - For DC input, C1 is used as an EMC filter capacitor. The recommended C1 value is 10 $\mu$ F/400V. When the input voltage is above 370VDC, we recommend a 10 $\mu$ F/450V capacitor.
  - C2 and C3 are output filter capacitors, we recommend high frequency and low impedance electrolytic capacitors. For capacitance and rated ripple current of capacitors refer to the datasheets provided by the manufacturers, voltage derating of capacitors should be 80% or above.
  - C4 is a ceramic capacitor which is used to filter high frequency noise. C2, C3 and L1 form a pi-type filter circuit. For current of L1 and L2 refer to the datasheets provided by the manufacturers, current derating should be 80% or above. TVS is a recommended component to protect post-circuits (if converter fails). We recommend using a 5D-9 external input NTC.
  - For standard EMC requirements, please refer to figure 2. If a higher EMC is required, please refer to figure 3.
  - All specifications measured at Ta=25C, humidity <75%, 115 Vac & 230 Vac input voltage, and rated output load, unless otherwise specified.



## REVISION HISTORY

---

rev.	description	date
1.0	initial release	08/09/2013
1.01	added 3.3 Vdc output model, added bent pin model options, updated emc recommendations	03/25/2014

The revision history provided is for informational purposes only and is believed to be accurate.



**Headquarters**  
20050 SW 112th Ave.  
Tualatin, OR 97062  
**800.275.4899**

Fax 503.612.2383  
**cui.com**  
techsupport@cui.com

CUI offers a two (2) year limited warranty. Complete warranty information is listed on our website.

CUI reserves the right to make changes to the product at any time without notice. Information provided by CUI is believed to be accurate and reliable. However, no responsibility is assumed by CUI for its use, nor for any infringements of patents or other rights of third parties which may result from its use.

CUI products are not authorized or warranted for use as critical components in equipment that requires an extremely high level of reliability. A critical component is any component of a life support device or system whose failure to perform can be reasonably expected to cause the failure of the life support device or system, or to affect its safety or effectiveness.