



MODEL: PJ-075DH-SMT-TR | **DESCRIPTION:** DC POWER JACK

FEATURES

- 1.3 mm center pin
- 3.5 A rating
- low profile
- surface mount (SMT)
- internal switch



SPECIFICATIONS

| parameter | conditions/description | min | typ | max | units |
|---------------------------------|--|-----|-------|----------|----------|
| rated input voltage | | | 24 | | Vdc |
| rated input current | | | | 3.5 | A |
| contact resistance ¹ | between terminal and mating plug between terminal in a closed circuit | | | 50 30 | mΩ mΩ |
| insulation resistance | at 500 Vdc | 100 | | | MΩ |
| voltage withstand | for 1 minute | | | 500 | Vac |
| insertion/withdrawal force | | 0.3 | | 3 | kg |
| operating temperature | | -25 | | 85 | °C |
| life | at a rate of 24 cycles/minute | | 5,000 | | cycles |
| flammability rating | UL94V-0 | | | | |
| RoHS | 2011/65/EU | | | | |

Note: 1. When measured at a current of less than 100 mA/1 kHz
 2. All specifications measured at 10~35°C, humidity at 45~85%, under standard atmospheric pressure, unless otherwise noted.

SOLDERABILITY

| parameter | conditions/description | min | typ | max | units |
|--------------------------------|--|-----|-----|-----|-------|
| reel storage | at relative humidity <80% | | | 40 | °C |
| reflow soldering ³ | see reflow profile | 255 | 260 | 265 | °C |
| drying conditions ⁴ | parts in reel: bake at 40°C ±5°C for 72 hours parts removed from reel: bake at 40°C ±5°C for 10 hours | | | | |

Note: 3. Must reflow solder within 72 hours from opening vacuum packaging at a temperature <30°C & relative humidity <60%.
 4. When exceeding floor life by >72 hours.



MECHANICAL DRAWING

units: mm[inches]
 tolerance:
 X.X ±0.2mm
 X.XX ±0.1mm
 X.XXX ±0.05mm

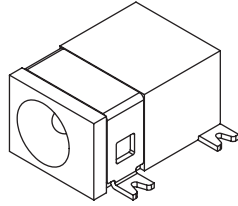

| | MATERIAL | PLATING |
|------------|--------------------|---------|
| center pin | copper | nickel |
| terminal 1 | brass | silver |
| terminal 2 | copper alloy | silver |
| terminal 3 | brass | silver |
| shield | brass | silver |
| plastic | PA6T or equivalent | |

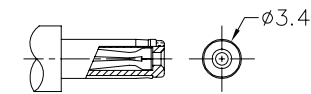
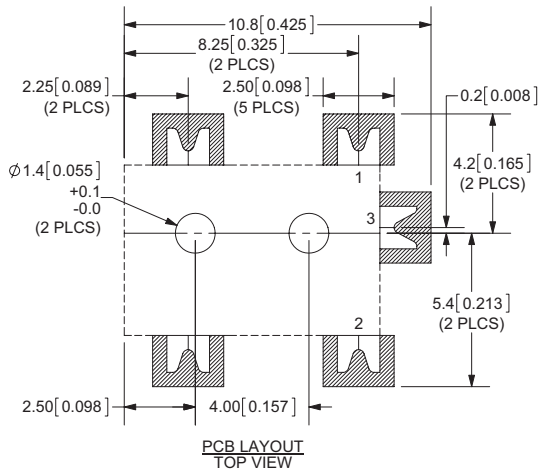
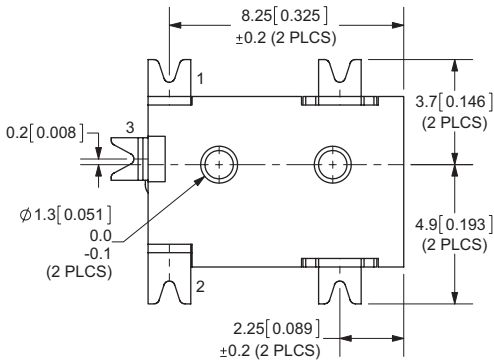
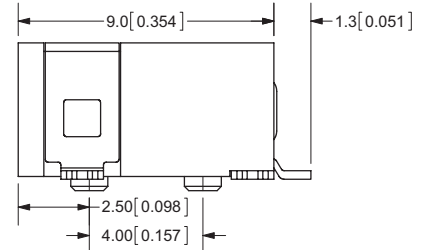
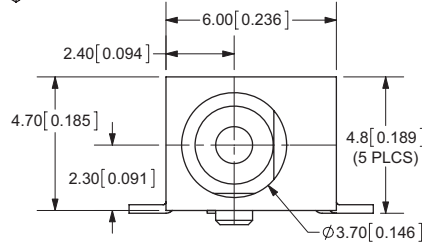
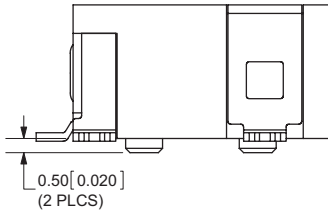

MATING PLUG
 Jack Insertion Depth: 6.4mm

| | |
|------------|--------------|
| SCHEMATIC | |
| Model | PJ-075DH-SMT |
| Center Pin | Ø1.3 mm |

PACKAGING

units: mm

Reel Size: $\varnothing 381$ mm

Reel QTY: 950 pcs per reel

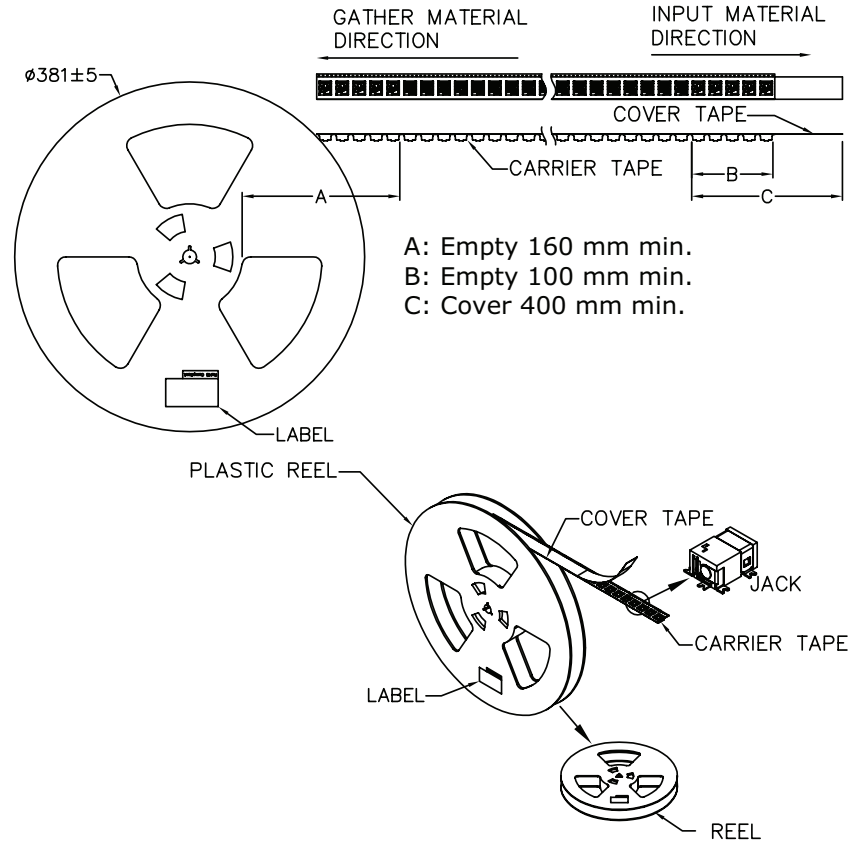
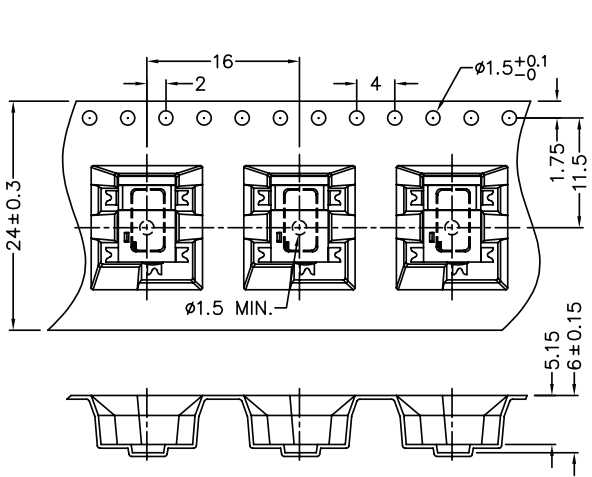

REVISION HISTORY

| rev. | description | date |
|------|--|------------|
| 1.0 | initial release | 03/16/2012 |
| 1.01 | increased voltage rating | 05/17/2016 |
| 1.02 | added storage and drying conditions, and tape and reel packaging details | 07/24/2017 |

The revision history provided is for informational purposes only and is believed to be accurate.



CUI INC[®]

Headquarters
20050 SW 112th Ave.
Tualatin, OR 97062
800.275.4899

Fax 503.612.2383
cui.com
techsupport@cui.com

CUI offers a one (1) year limited warranty. Complete warranty information is listed on our website.

CUI reserves the right to make changes to the product at any time without notice. Information provided by CUI is believed to be accurate and reliable. However, no responsibility is assumed by CUI for its use, nor for any infringements of patents or other rights of third parties which may result from its use.

CUI products are not authorized or warranted for use as critical components in equipment that requires an extremely high level of reliability. A critical component is any component of a life support device or system whose failure to perform can be reasonably expected to cause the failure of the life support device or system, or to affect its safety or effectiveness.