

RE25S

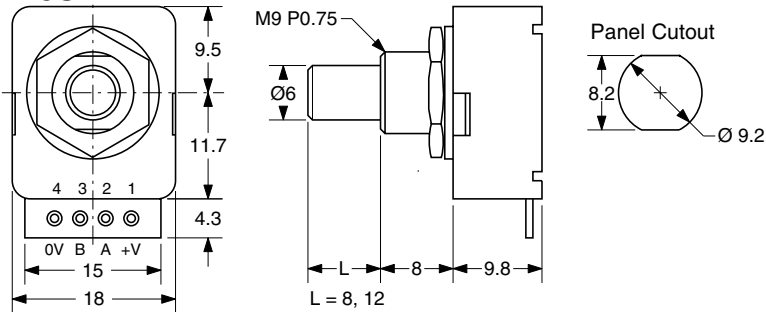

RE25V

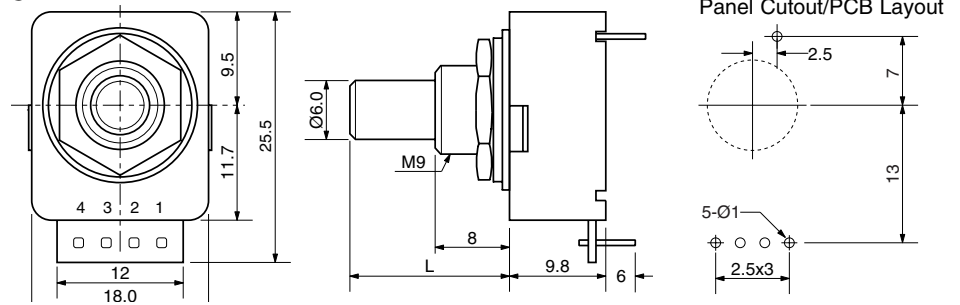

RE25F

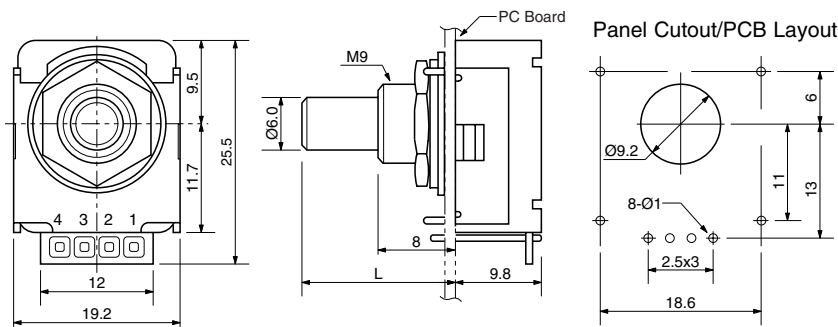

RE25C

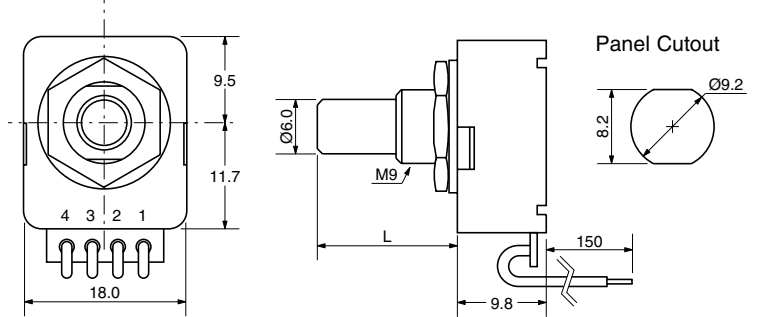

SPECIFICATIONS

ELECTRICAL

1. Input Power: 5.0 VDC $\pm 10\%$ @ 10mA
3.3 VDC $\pm 10\%$ @ 10mA
2. Output Voltage: H = Vcc - 0.4V
L 0.4V
3. Resolution: 16, 25 PPR
3. Output Type: TTL/CMOS Compatible
4. Max. Freq. Response: 500 Hz

MECHANICAL

1. Max Shaft Load, radial: 1.0 kgf
axial: 1.0 kgf
2. Rotational Angle: 360° continuous
3. Click Torque: 100 gf cm max.
4. Rotational Life: 2.5 x 10⁶ cycles

ENVIRONMENTAL

1. Operating Temp: 0° to +60° C
2. Storage Temp: -20° to +80° C
3. Humidity: 85% RH, no condensation
4. Vibration: 10~55 Hz, 1.5 mm, 2 hrs
5. Shock: 50G, 6ms, 3 axes, 3 reps

OUTPUT CIRCUIT

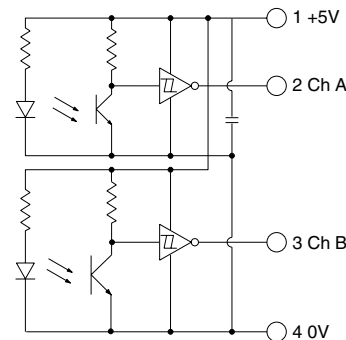

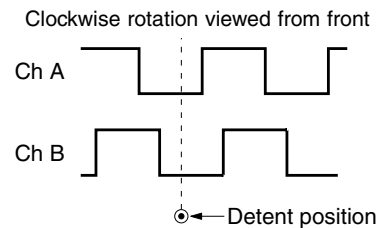

OUTPUT WAVEFORM

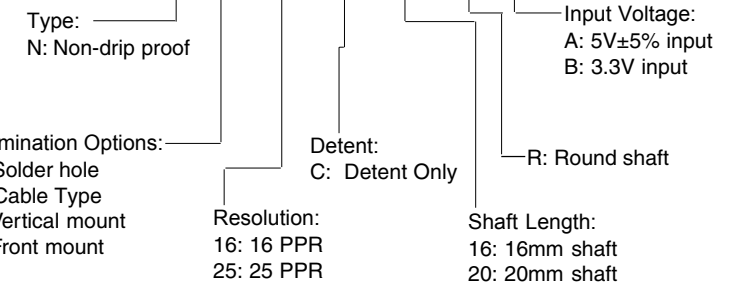

ORDERING INSTRUCTIONS

RE25X XX C XX R X



 <p>CUI Inc. 20050 SW 112th Ave. Tualatin, OR 97062 Tel: 503/612-2300 FAX: 503/612-2383</p>			
PART NO. RE25XXXXCXXX			REV. A