



**SERIES:** SDI12-UD | **DESCRIPTION:** AC-DC POWER SUPPLY

**FEATURES**

- up to 12 W continuous power
- DoE Level VI, CoC Tier 2 efficiency
- no load power consumption < 0.075 W
- compact size
- universal input voltage range
- over voltage, over current, and short circuit protections
- UL/cUL, GS, CE, PSE safety approvals



MODEL	output voltage (Vdc)	output current max (A)	output power max (W)	ripple and noise <sup>1</sup> max (mVp-p)	efficiency level <sup>2</sup>
SDI12-5-UD	5	2	10	100	VI
SDI12-5.9-UD	5.9	2	11.8	100	VI
SDI12-9-UD	9	1.33	12	100	VI
SDI12-12-UD	12	1	12	120	VI
SDI12-15-UD	15	0.8	12	150	VI
SDI12-18-UD	18	0.67	12	180	VI
SDI12-24-UD	24	0.5	12	240	VI

Notes: 1. At full load, nominal input, 20 MHz bandwidth oscilloscope, each output terminated with 0.1 µF multilayer ceramic and 47 µF low ESR electrolytic capacitors.  
2. CoC Tier 2 compliant

**PART NUMBER KEY**

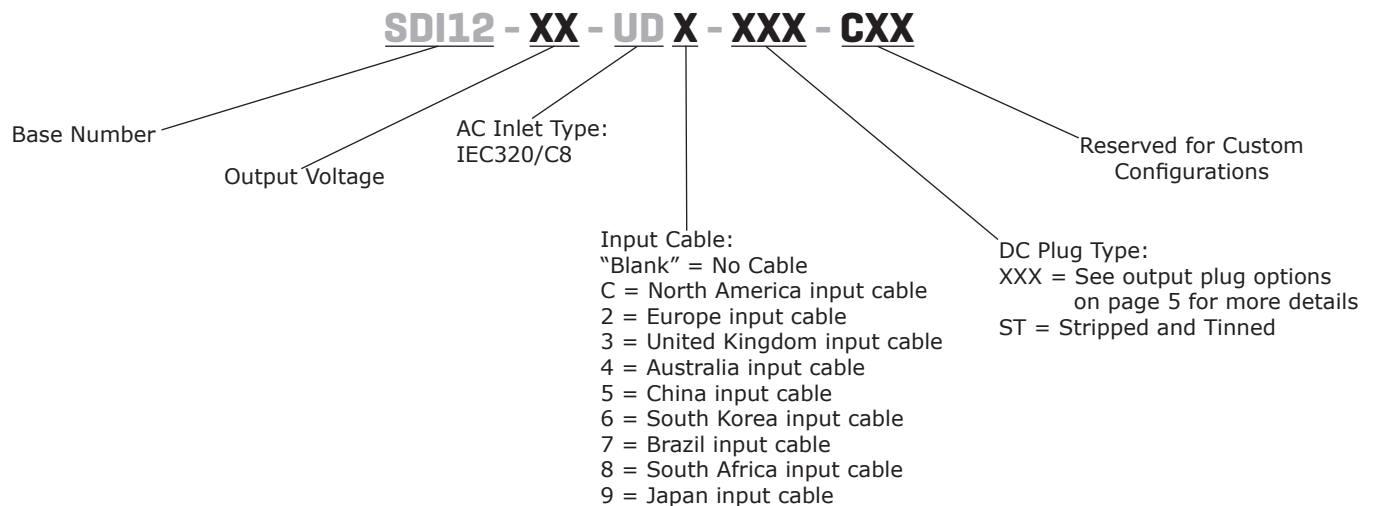

## INPUT

parameter	conditions/description	min	typ	max	units
voltage		90		264	Vac
frequency		47		63	Hz
current	at full load			0.31	A
inrush current	at 240 Vac, full load, 25°C, cold start			60	A
leakage current				0.25	mA
no load power consumption	at 115/230 Vac			0.1	W
	Level VI CoC Tier 2			0.075	W

## OUTPUT

parameter	conditions/description	min	typ	max	units
regulation			±5		%
hold-up time	at full load	10			ms

## PROTECTIONS

parameter	conditions/description	min	typ	max	units
over voltage protection	output shut down				
	5 Vdc output model			9	Vdc
	5.9 Vdc output model			10.6	Vdc
	9 Vdc output model			16.2	Vdc
	12 Vdc output model			21.6	Vdc
	15 Vdc output model			27	Vdc
over current protection	18 Vdc output model			32.4	Vdc
	24 Vdc output model			45	Vdc
	output shut down, auto recovery				
	5 Vdc output model			5	A
	5.9 Vdc output model			5	A
	9 Vdc output model			3	A
short circuit protection	12 Vdc output model			2.5	A
	15 Vdc output model			2	A
	18 Vdc output model			2	A
	24 Vdc output model			1.5	A

## SAFETY & COMPLIANCE

parameter	conditions/description	min	typ	max	units
isolation voltage	input to output at 10 mA for 1 minute		3,000		Vac
isolation resistance	input to output at 500 Vdc	10			MΩ
safety approvals	UL/cUL, GS, LPS, PSE				
EMI/EMC	FCC Part 15B Class B, CE				
MTBF	as per Telcordia SR-332, 25°C	300,000			hours
RoHS	2011/65/EU				

## ENVIRONMENTAL

parameter	conditions/description	min	typ	max	units
operating temperature		0		40	°C
storage temperature		-20		80	°C
operating humidity	non-condensing	20		80	%
storage humidity	non-condensing	10		90	%

## MECHANICAL

parameter	conditions/description	min	typ	max	units
dimensions	75 x 48 x 30				mm
inlet plug	IEC320/C8				
weight	without ac cord		126		g

## MECHANICAL DRAWING

units: mm  
tolerance: ±0.5 mm



## DC CORD

units: mm

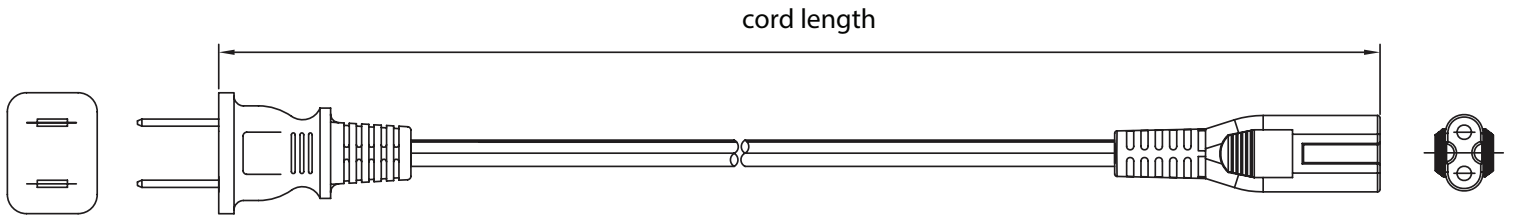

**Table 1**

MODEL NO.	CABLE	CORD LENGTH
SDI12-5-UD	UL2468, 20 AWG	1,500 mm ±30
SDI12-5.9-UD	UL2468, 20 AWG	1,500 mm ±30
SDI12-9-UD	UL2468, 20 AWG	1,500 mm ±30
SDI12-12-UD	UL2468, 22 AWG	1,500 mm ±30
SDI12-15-UD	UL2468, 22 AWG	1,500 mm ±30
SDI12-18-UD	UL2468, 22 AWG	1,500 mm ±30
SDI12-24-UD	UL2468, 22 AWG	1,500 mm ±30

## AC CORD

units: mm



### NORTH AMERICA



### EUROPE



### UNITED KINGDOM

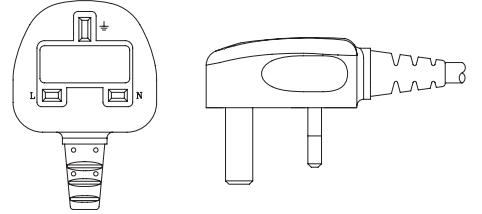

### AUSTRALIA

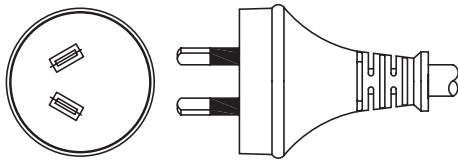

### CHINA

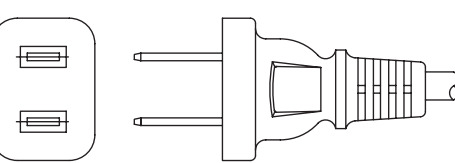

### SOUTH KOREA

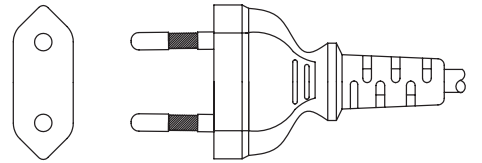

### BRAZIL



### SOUTH AFRICA



### JAPAN

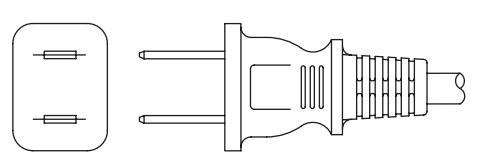

**Table 2**

AC INPUT	CORD LENGTH
North America	1,830 mm ±50
Europe	1,830 mm ±50
United Kingdom	1,830 mm ±30
Australia	1,830 mm ±30
China	1,830 mm ±30
South Korea	1,830 mm ±50
Brazil	1,830 mm ±30
South Africa	1,830 mm ±50
Japan	1,830 mm ±50

## OUTPUT PLUG OPTIONS

### Standard DC Plug



Size	A	B	C	Unit
5	5.5	2.1	9.5	mm
6	5.5	2.5	9.5	mm
7	3.5	1.35	9.5	mm
8	3.8	1.35	9.5	mm
9	3.8	1.05	9.5	mm

### Locking DC Plug



Size	A	B	C	Unit
10	5.5	2.1	9.5	mm
11	5.5	2.5	9.5	mm

### EIAJ DC Plug



Size	EIAJ	A	B	C	Unit
12	EIAJ-1	2.35	0.7	9.5	mm
13	EIAJ-2	4.0	1.7	9.5	mm
14	EIAJ-3	4.75	1.7	9.5	mm

### Stripped and Tinned



### DC Plug Type



\*Contact CUI for additional plug options

## REVISION HISTORY

rev.	description	date
1.0	initial release	08/21/2015
1.01	updated datasheet	05/18/2016
1.02	updated datasheet	09/15/2016

The revision history provided is for informational purposes only and is believed to be accurate.



**CUI INC**<sup>®</sup>

**Headquarters**  
20050 SW 112th Ave.  
Tualatin, OR 97062  
**800.275.4899**

Fax 503.612.2383  
**cui.com**  
techsupport@cui.com

This device complies with part 15 of the FCC Rules. Operation is subject to the following two conditions:

- (1) This device may not cause harmful interference, and
- (2) this device must accept any interference received, including interference that may cause undesired operation.

CUI offers a one (1) year limited warranty. Complete warranty information is listed on our website.

CUI reserves the right to make changes to the product at any time without notice. Information provided by CUI is believed to be accurate and reliable. However, no responsibility is assumed by CUI for its use, nor for any infringements of patents or other rights of third parties which may result from its use.

CUI products are not authorized or warranted for use as critical components in equipment that requires an extremely high level of reliability. A critical component is any component of a life support device or system whose failure to perform can be reasonably expected to cause the failure of the life support device or system, or to affect its safety or effectiveness.