

REV.	DESCRIPTION	DATE
A	NEW DRAWING	1/3/2006
B	updated PCB layout	2/6/2008
C	added TR package option	11/29/2012

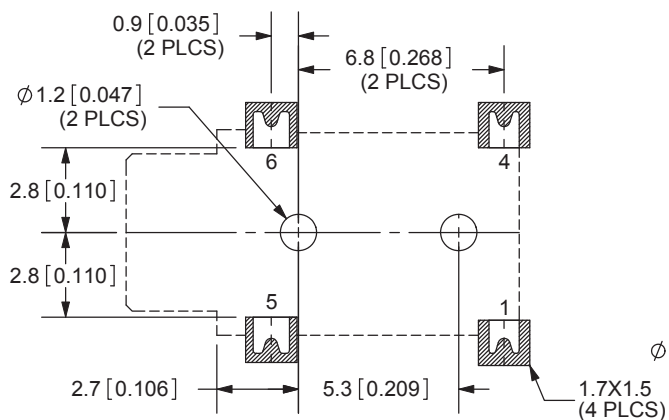

PCB LAYOUT  
TOP VIEW

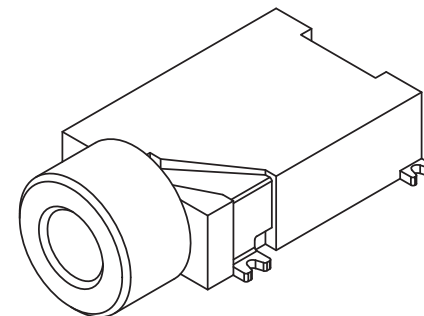
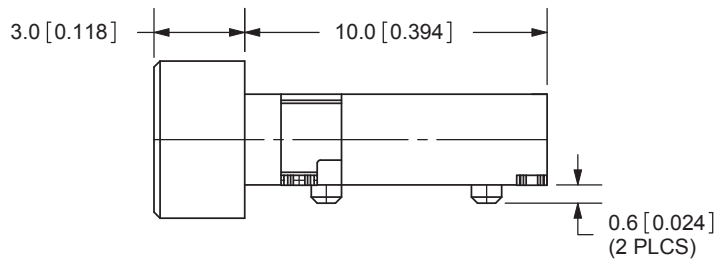
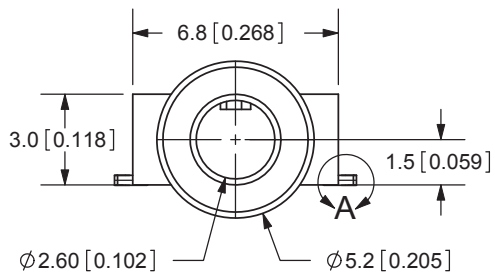
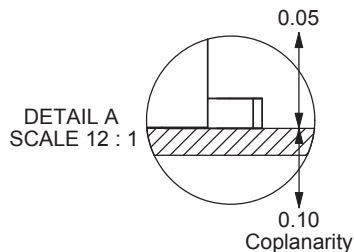
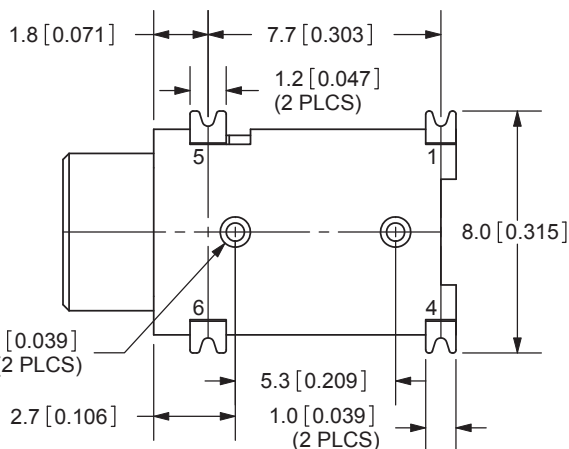

Note:  
Add suffix "-TR" to the model number for  
tape & reel packaging

TOLERANCE:  
X.X  $\pm 0.3$ mm  
X.XX  $\pm 0.2$ mm

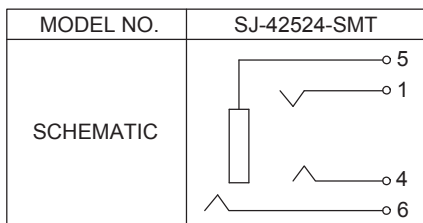

**SPECIFICATIONS:**  
 RATING: 16V DC @ 300mA  
 CONTACT RESISTANCE: 100m OHMS MAX  
 INSULATION RESISTANCE: 100M OHMS MIN: 500V DC  
 VOLTAGE WITHSTAND: 500V AC R.M.S. FOR 1 MINUTE  
 LIFE: 5,000 CYCLES  
 OPERATING TEMP: -40 ~ +85C

	MATERIAL	PLATING
TERMINAL 1	Titanium Copper	Silver
TERMINAL 4	Titanium Copper	Silver
TERMINAL 5	Phosphor Bronze	Silver
TERMINAL 6	Brass	Gold
HOUSING	PBT	



20050 SW 112th Ave.  
 Tualatin, OR 97062  
 Phone: 503-612-2300  
 800-275-4899  
 Fax: 503-612-2383  
 Website: www.cui.com

TITLE:	SMT AUDIO JACK W/4 CONDUCTORS 2.5mm	REV:	C
PART NO.	SJ-42524-SMT	UNITS:	MM [INCHES]
DRAWN BY:	ZRJ	APPROVED BY:	
		SCALE:	4:1

PC FILE NAME:  
SJ-42524-SMT

COPYRIGHT 2012 BY CUI INC.

REV.	DESCRIP
A	NEW DRAWING
B	updated PCB
C	added TR package

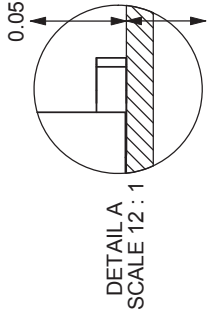

Coplanarity

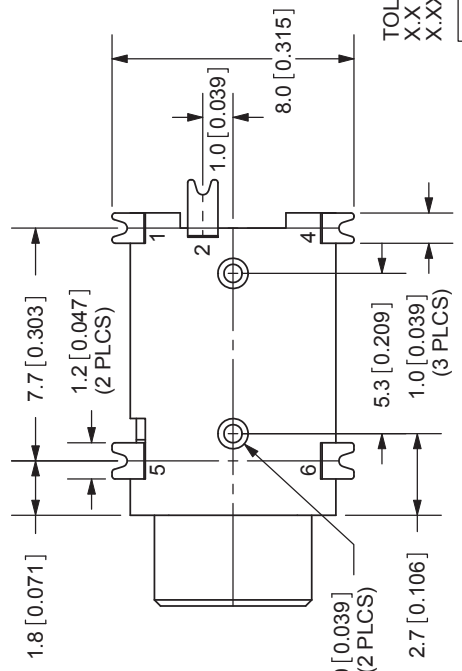
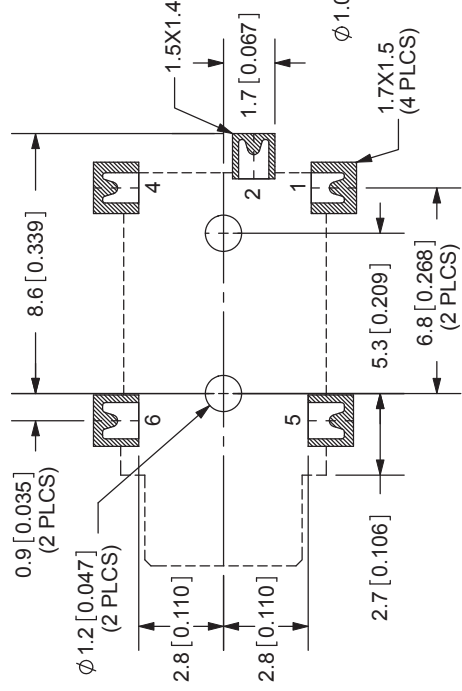
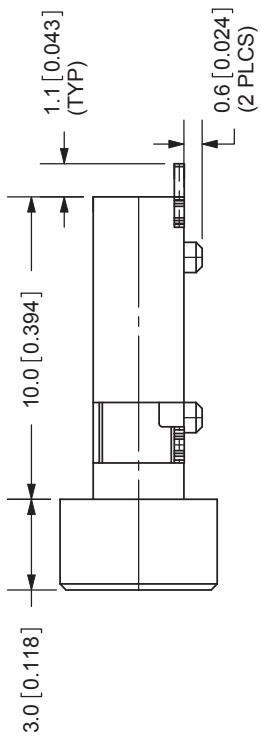
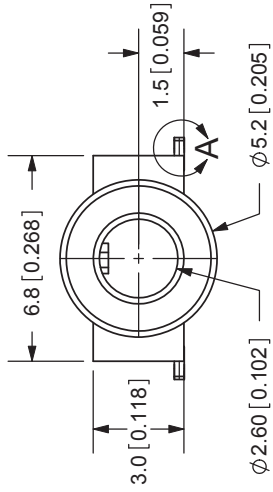

TOLERANCE  
X.X ±0.3mm  
X.XX ±0.2mm

Note:  
Add suffix  
tap & r

For more information, please visit the [product page](#).

PCB LAYOUT  
TOP VIEW

SPECIFICATIONS:  
RATING: 16V DC @ 300mA  
CONTACT RESISTANCE: 100m OHMS MAX  
INSULATION RESISTANCE: 100M OHMS MIN: 500V DC  
VOLTAGE WITHSTAND: 500V AC R.M.S. FOR 1 MINUTE  
LIFE: 5,000 CYCLES  
OPERATING TEMP: -40 ~ +85C

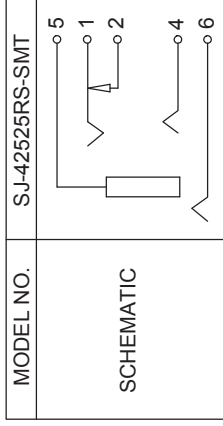

TERMINAL	MATERIAL	PLATING
TERMINAL 1	Titanium Copper	Silver
TERMINAL 2	Brass	Silver
TERMINAL 4	Titanium Copper	Silver
TERMINAL 5	Phosphor Bronze	Silver
TERMINAL 6	Brass	Gold
HOUSING	PBT	

PC FILE NAME:  
SJ-42525RS-SMT

COPYRIGHT 2012 BY CUJ, INC.

TITLE: SMT AUDIO JACK  
PART NO: SJ-42525R  
DRAWN BY: ZRJ

REV.	DESCRIP
A	NEW DRAWING
B	updated PCB
C	housing material
D	added TR package

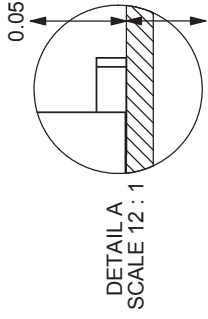

Coplanarity

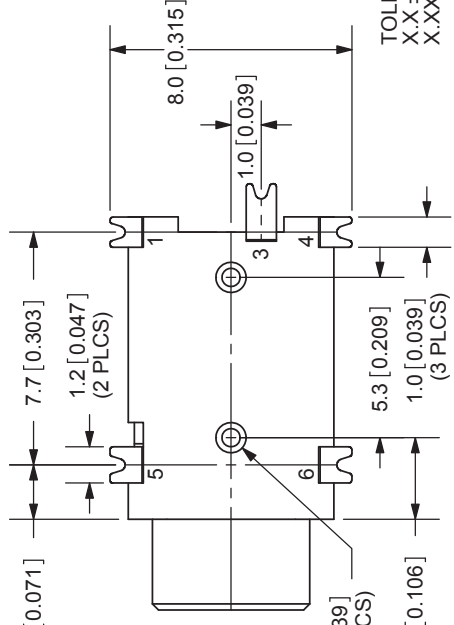
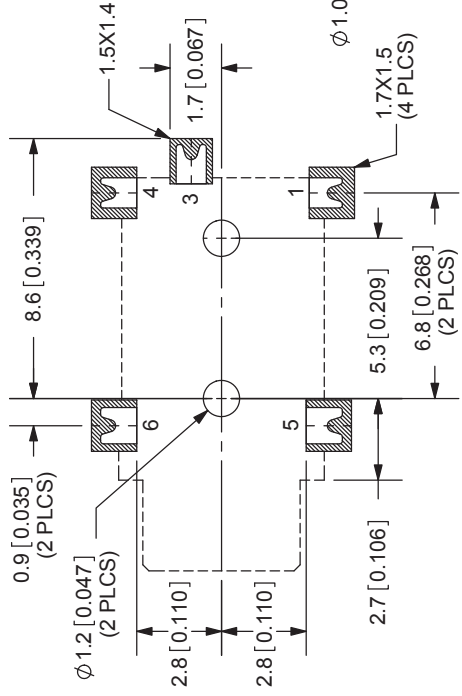
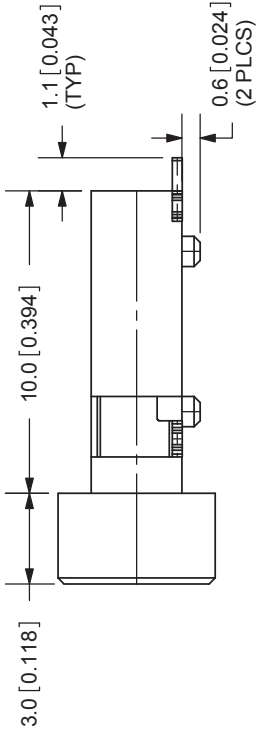
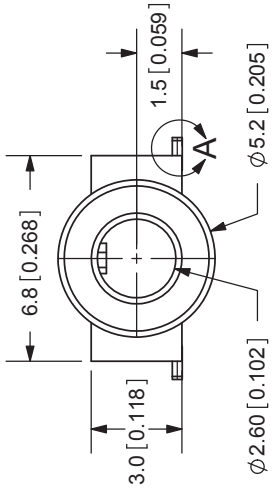

TOLERANCE  
X.X ±0.3mm  
X.XX ±0.2mm

Note: SMT  
Add SMT re  
taped re

For more information, please visit the [product page](#).

PCB LAYOUT  
TOP VIEW

SPECIFICATIONS:  
RATING: 16V DC @ 300mA  
CONTACT RESISTANCE: 100m OHMS MAX  
INSULATION RESISTANCE: 100M OHMS MIN: 500V DC  
VOLTAGE WITHSTAND: 500V AC R.M.S. FOR 1 MINUTE  
LIFE: 5,000 CYCLES

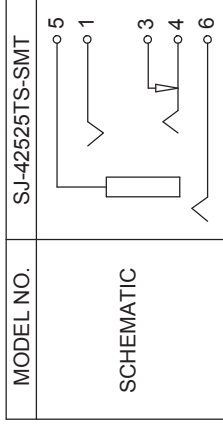

TERMINAL	MATERIAL	PLATING
TERMINAL 1	Titanium Copper	Silver
TERMINAL 3	Brass	Silver
TERMINAL 4	Titanium Copper	Silver
TERMINAL 5	Phosphor Bronze	Silver
TERMINAL 6	Brass	Gold
HOUSING	LCP	

PC FILE NAME:

SJ-42525TS-SMT

COPYRIGHT 2012 BY CUJ INC.

TITLE: SMT AUDIO J

PART NO: SJ-42525T

DRAWN BY: ZRJ

REV.	DESCRIP
A	NEW DRAWING
B	updated PCB
C	housing material
D	added TR package

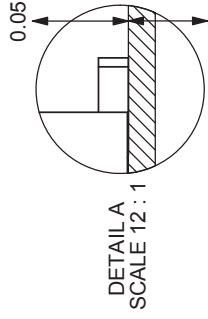

Coplanarity

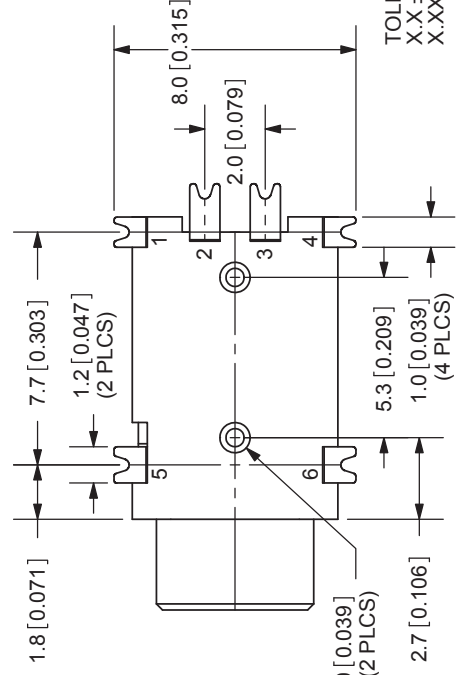
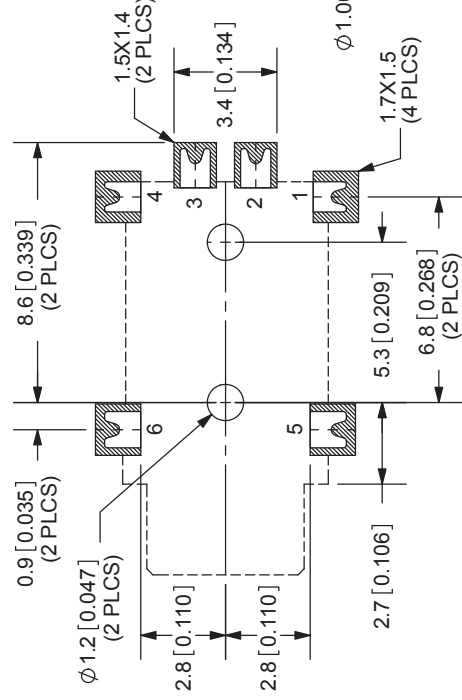
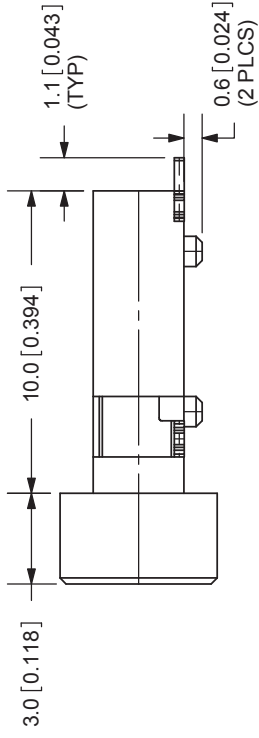
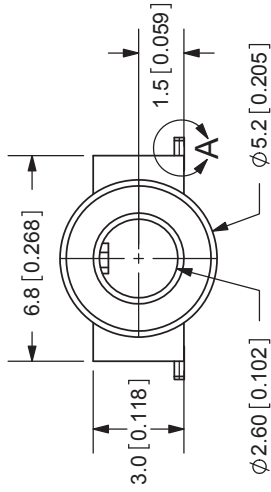

TOLERANCE  
X.X ±0.3mm  
X.XX ±0.2mm

PCB LAYOUT  
TOP VIEW

SPECIFICATIONS:  
RATING: 16V DC @ 300mA  
CONTACT RESISTANCE: 100m OHMS MAX  
INSULATION RESISTANCE: 100M OHMS MIN: 500V DC  
VOLTAGE WITHSTAND: 500V AC R.M.S. FOR 1 MINUTE  
LIFE: 5,000 CYCLES

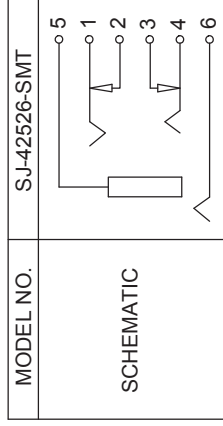

MODEL NO. SJ-42526-SMT

TERMINAL	MATERIAL	PLATING
TERMINAL 1	Titanium Copper	Silver
TERMINAL 2	Brass	Silver
TERMINAL 3	Brass	Silver
TERMINAL 4	Titanium Copper	Silver
TERMINAL 5	Phosphor Bronze	Silver
TERMINAL 6	Brass	Gold
HOUSING	LCP	

PC FILE NAME:

SJ-42526-SMT

COPYRIGHT 2012 BY CUJ INC.

For more information, please visit the [product page](#).



TITLE: SMT AUDIO JACK  
PART NO: SJ-42526-SMT  
DRAWN BY: ZRJ