

**SERIES:** VDRS-150 | **DESCRIPTION:** AC-DC DIN RAIL

**FEATURES**

- up to 150 W continuous power
- universal input (88~264 Vac / 124~373 Vdc)
- 150% peak load capability<sup>2</sup>
- DIN Rail power supplies
- two peak load mode selector
- built-in remote ON/OFF function
- over voltage, over load, and over temperature protections
- UL 508 and TUV safety approvals
- built-in active PFC function (PF 0.90 at 115 Vac, 0.98 at 230 Vac)
- efficiency up to 87%



<b>MODEL</b>	<b>output voltage</b> (Vdc)	<b>output current max</b> (A)	<b>output power max</b> (W)	<b>ripple and noise<sup>1</sup> max</b> (mVp-p)	<b>efficiency</b> (%)
VDRS-150-24	24	6.3	150	240	87
VDRS-150-48	48	3.2	150	480	87

Note: 1. at full load, 230 Vac input, measured at 20MHz bandwidth with a 47  $\mu$ F and 0.1  $\mu$ F parallel cap on the output  
 2. 3 seconds or 20% duty cycle max. The average output power should not exceed the rated power.

**PART NUMBER KEY**

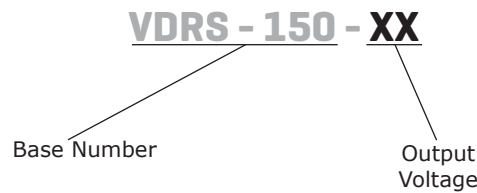

**INPUT**

parameter	conditions/description	min	typ	max	units
voltage		88		264	Vac
		124		373	Vdc
frequency		47		63	Hz
current	at 115 Vac			2.6	A
	at 230 Vac			1.3	A
inrush current	at 115 Vac			33	A
	at 230 Vac			65	A
power factor correction	at 230 Vac			0.90	
	at 115 Vac			0.98	
leakage current	at 240 Vac			1	mA

**OUTPUT**

parameter	conditions/description	min	typ	max	units
voltage accuracy				±1	%
line regulation				±0.5	%
load regulation			5	±1	%
temperature coefficient	(0 ~ 50°C)		±0.03		%/°C
hold-up time	at 115 / 230 Vac, cold start	16			ms
voltage adjustment range		-2		+8	%

Note: 1. All specification are measured at 230 Vac input, rated load, 25°C unless otherwise specified.

**PROTECTIONS**

parameter	conditions/description	min	typ	max	units
	latch-off mode, restart	24 V model	120		%
	to recover from fault	48 V model	117		%
over voltage protection	Kicks in between 105~150% rated output power when the fault persist for about 3 sec, then clamps output voltage down, automatic recovery' >150% rated power or short circuit would cause the power supply to go in to constant current limiting; if fault condition is not removed after 5 times, then the converter will shutdown and need to be restarted to recover from fault.				
over load protection	constant current limiting, automatically recovers after fault condition is removed	105		150	%
over temperature protection	output shut down and auto restart upon reduction of temperature	90	95	100	°C
DC ok relay contact ratings	at 0.3 A			60	Vdc
	at 1 A and 0.5 A			30	Vdc

**SAFETY & COMPLIANCE**

parameter	conditions/description	min	typ	max	units
isolation voltage	input to output for 1 minute			4,242	Vdc
	input to case for 1 minute			2,121	Vdc
	output to case, output to DC OK for 1 minute			707	Vdc
isolation resistance	input to output, input to case, output to case, 500 Vdc	100			MΩ
safety approvals	UL 508, TUV EN 60950-1				
EMI/EMC <sup>2</sup>	EN 55022 (CISPR22) Class B, EN 61000-3-(2, 3), EN 61000-4-(2,3,4,5,6,8,11) ENV 50204, EN 55024, EN 61000-6-2 (EN50082-2), EN 61204-3, heavy industry level, criteria A, meet SEMI F47				
RoHS compliant	yes				

Note: 2. The power supply is considered a component which will be installed into a final equipment. The final equipment must be re-confirmed that it still meets EMC directives.

**ENVIRONMENTAL**

parameter	conditions/description	min	typ	max	units
operating temperature		-10		70	°C
storage temperature		-40		85	°C
operating humidity	non-condensing	20		90	%
storage humidity		10		95	%
vibration	(10 ~ 500 Hz, 1 hour per axis, 3 hours total)		2		Grms

## MECHANICAL

parameter	conditions/description	min	typ	max	units
dimensions	2.185 x 4.921 x 3.929 (55.5 x 125 x 99.8 mm)				inch

## MECHANICAL DRAWING

CN1	
1	FG ⊕
2	ac line
3	ac neutral

CN2	
1	DC+
2	DC-
3	INH+
4	INH-
5	relay contact
6	relay contact

Switch	
1	peak load setting
2	remote on/off setting

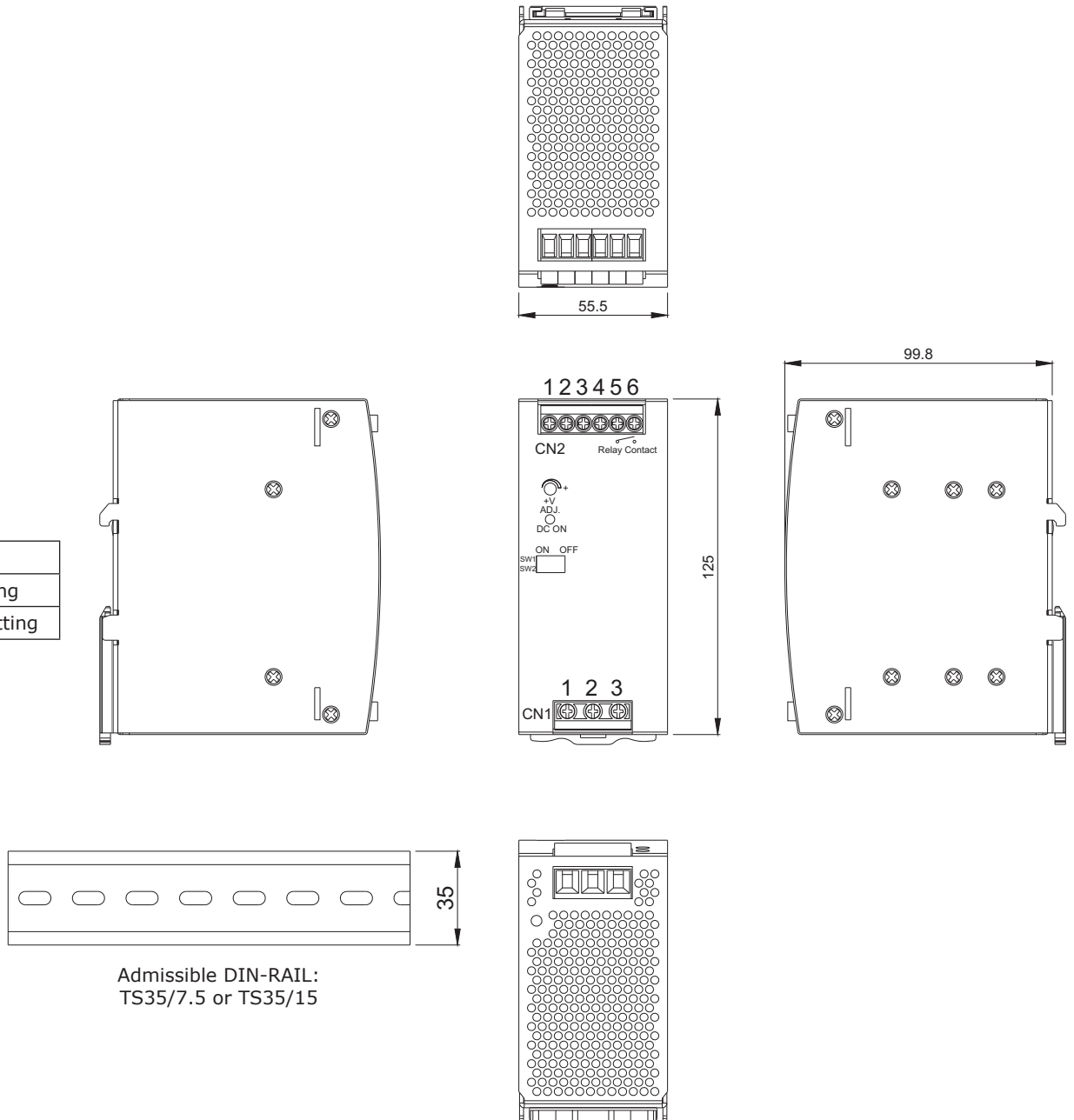

## PEAK LOADING SW1 ON (MODE1) DEFAULT SETTING

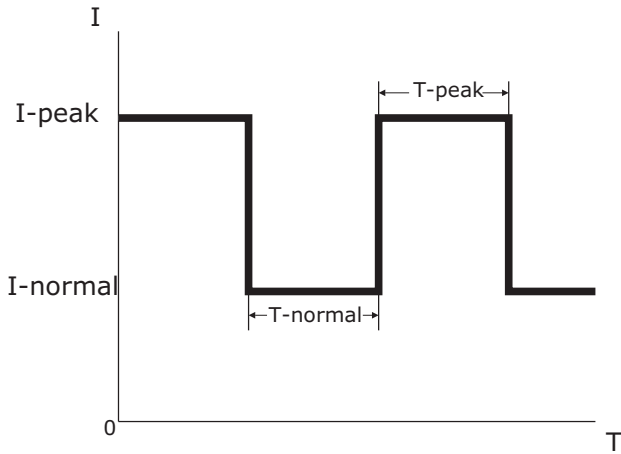

T-peak presents while the unit is working within 110%~150% rated output power. See Curve "B" for the variation in T-Peak between output current and hold-up time. If T-peak is more than the time setting in Curve "B", the output current will drop to the constant limit (I-normal) that is 105% of the rated power. Meanwhile, I-normal and T-normal will be presenting. See Curve "A" for the timing back to I-Peak of T-normal and this mode can be used for easy 2-stage battery chargers.

## PEAK LOADING SW1 OFF (MODE2)

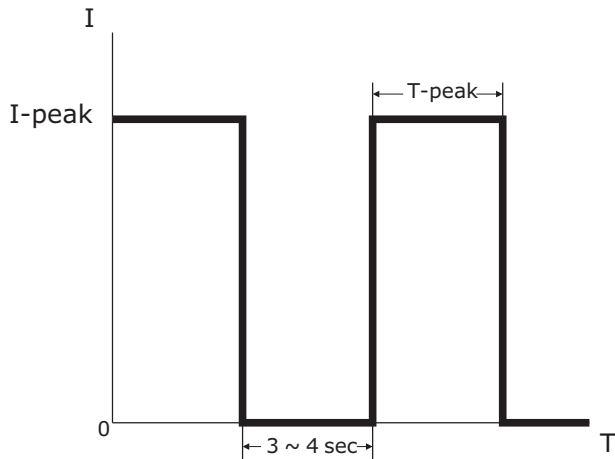

T-peak presents while the unit is working within 110%~150% rated output power. See Curve "B" for the variation of T-peak between output current and hold-up time. If T-peak is more than the time setting in Curve "B", the output voltage will be shut down for 3~4 seconds and then auto-recover.

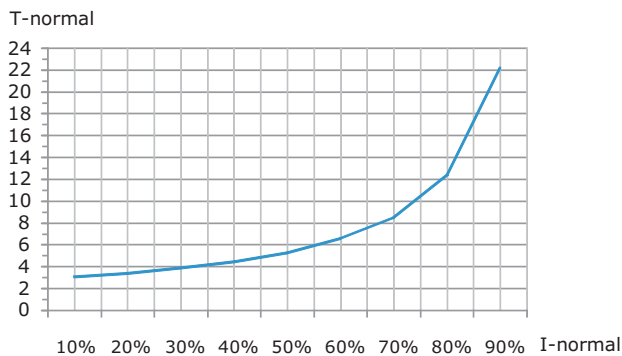

CURVE A

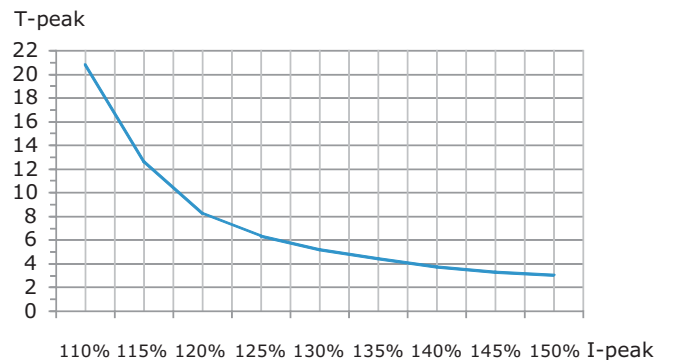

CURVE B

## REMOTE ON/OFF

The power supply can be turned on/off by using the "remote control" function.

SW2	INH+(3 PIN)/INH-(4 PIN)	Output Status
off	SW ON (>2.5 V)	ENABLE
off	SW OFF (<0.8 V)	DISABLE
on	SW ON (>2.5 V)	DISABLE
on	SW OFF (<0.8 V)	ENABLE

(default setting)

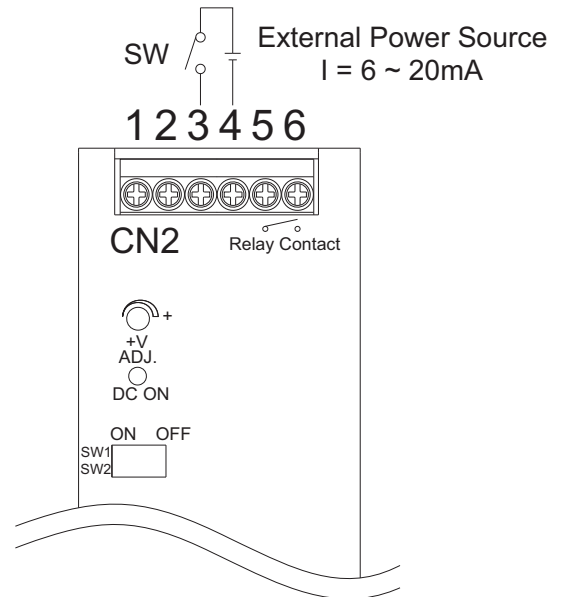

## DERATING CURVE

Output power vs. Ambient temperature

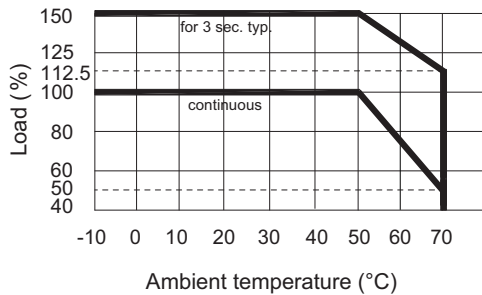

Output power vs. Input Voltage

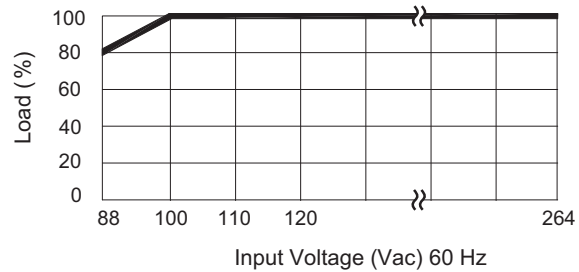

Note: 1. Derating may be needed under low input voltage. Please check the derating curve for more details.

## ACTIVE DC SIGNAL - RELAY CONTACT

Contact Close	When the output voltage reaches the adjusted output voltage
Contact Open	When the output voltage drops below 45%
Contact Ratings (MAX)	30 V / 1 A resistive load

## REVISION HISTORY

---

<b>rev.</b>	<b>description</b>	<b>date</b>
1.0	initial release	10/17/2012
1.01	spec. update	11/07/2012
1.02	spec. update	01/17/2013

The revision history provided is for informational purposes only and is believed to be accurate.



**CUI INC**<sup>®</sup>

**Headquarters**  
20050 SW 112th Ave.  
Tualatin, OR 97062  
**800.275.4899**

Fax 503.612.2383  
**cui.com**  
techsupport@cui.com

CUI offers a two (2) year limited warranty. Complete warranty information is listed on our website.

CUI reserves the right to make changes to the product at any time without notice. Information provided by CUI is believed to be accurate and reliable. However, no responsibility is assumed by CUI for its use, nor for any infringements of patents or other rights of third parties which may result from its use.

CUI products are not authorized or warranted for use as critical components in equipment that requires an extremely high level of reliability. A critical component is any component of a life support device or system whose failure to perform can be reasonably expected to cause the failure of the life support device or system, or to affect its safety or effectiveness.