

**SERIES:** ETSA 40W U | **DESCRIPTION:** AC-DC POWER SUPPLY

**FEATURES**

- 40 W power
- compact size
- universal input (90~264 Vac)
- single regulated output from 12~48 V
- over voltage and short circuit protection
- UL/cUL, GS, PSE safety approvals
- level V efficiency
- custom designs available



MODEL	output voltage	output current max	output power max	ripple and noise <sup>1</sup> max	efficiency level
	(Vdc)	(A)	(W)	(mVp-p)	
ETSA120330U	12	3.3	40	200	V
ETSA190210U	19	2.1	40	240	V
ETSA240167U	24	1.67	40	240	V
ETSA480083U	48	0.83	40	300	V

Notes: 1. At full load, 100 ~ 240 Vac input, 20 MHz bandwidth oscilloscope, each output terminated with 10  $\mu$ F aluminum electrolytic and 0.1  $\mu$ F ceramic capacitors.

**PART NUMBER KEY**

**ETSA120330U X - XX - SZ - CXX**

Base Number  
example of 12 Vdc, 3.3 A

DC Plug Type:  
see output plug options  
on page 7

Reserved for Custom  
Configurations

Input Cable:  
"Blank" = No Cable  
C = North American input cable  
2 = European input cable  
3 = United Kingdom input cable  
4 = Australian input cable  
5 = China input cable  
6 = South Korea input cable  
7 = Brazil input cable  
8 = South Africa input cable  
9 = Japan input cable

Factory  
Designation

**INPUT**

parameter	conditions/description	min	typ	max	units
voltage		90		264	Vac
frequency		47		63	Hz
inrush current				1.0	A
leakage current				3.5	mA
no load power consumption				0.3	W

**OUTPUT**

parameter	conditions/description	min	typ	max	units
line regulation			±1		%
load regulation			±5		%

**PROTECTIONS**

parameter	conditions/description
over voltage protection	protected through primary circuit IC
short circuit protection	output shut down, auto restart

**SAFETY & COMPLIANCE**

parameter	conditions/description	min	typ	max	units
isolation voltage	input to output at 10 mA for 1 minute			1,500	Vac
isolation resistance	input to output at 500 Vdc	100			MΩ
safety approvals	UL 60950-1, EN 60950-1/IEC 60950-1, GS, PSE <sup>1</sup>				
EMI/EMC	FCC part 15, subpart B, class B; CE; ICES-003; ANSI C63.4; EN 61204-3; EN 55022, class B; EN 55024; EN 61000-3-(2, 3); CISPR 22, class B; IEC 61000-4-(2, 3, 4, 5, 6, 8, 11)				
RoHS	2011/65/EU				

1. excluding the 48 V model

**ENVIRONMENTAL**

parameter	conditions/description	min	typ	max	units
operating temperature		0		40	°C
storage temperature		-10		70	°C
operating humidity		20		80	%
storage humidity		10		90	%

**MECHANICAL**

parameter	conditions/description	min	typ	max	units
dimensions	80.6 x 50 x 31 (3.173 x 1.969 x 1.220 inches)				mm
input plug	IEC320 / C14				
weight <sup>1</sup>	48 V model		290		g
	all other models		300		g

1. weight does not include AC Cord

**MECHANICAL DRAWING**

units: mm

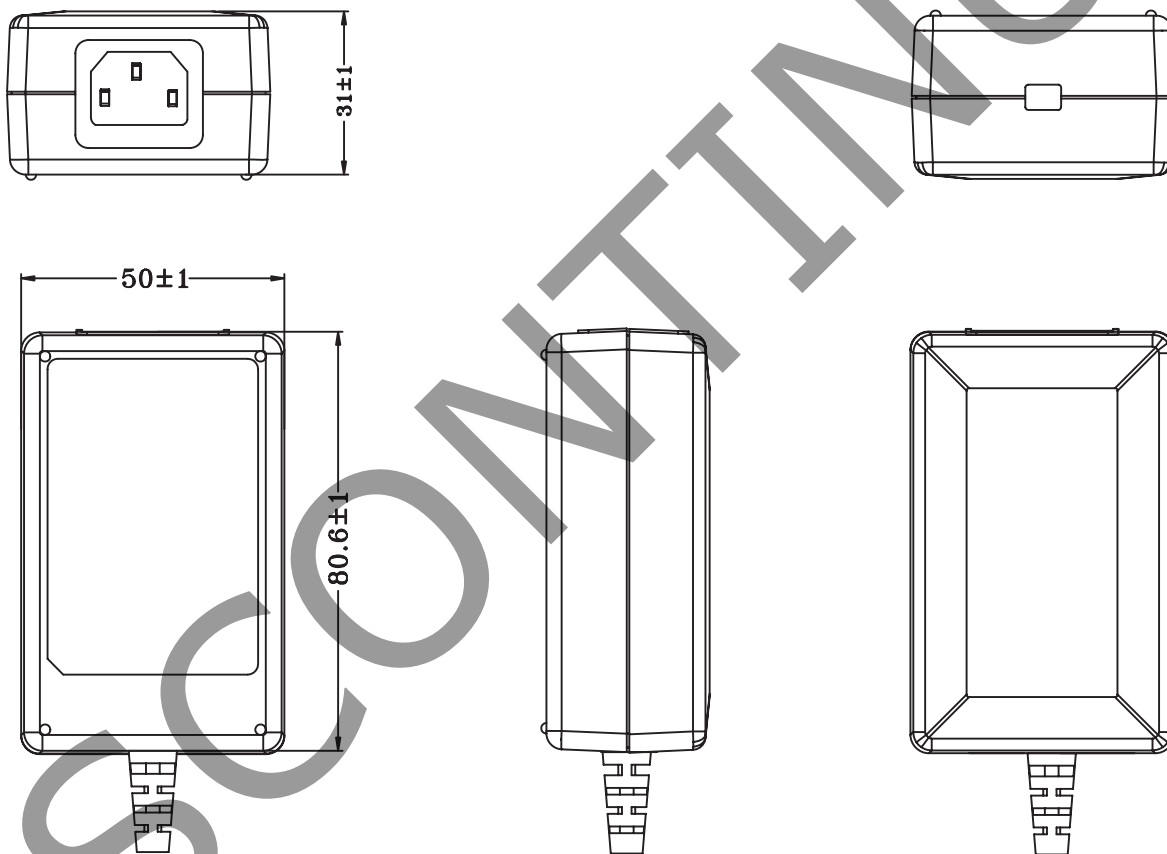
tolerance:  $\pm 1$ mm

## DC CORD

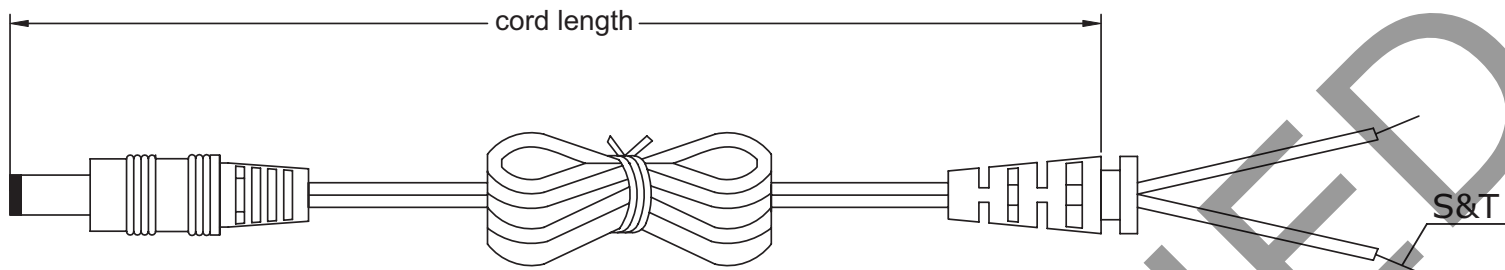

MODEL NO.	CABLE GAUGE	WIRE OD	CORD LENGTH
ETSA120330U	18 AWG	Ø2.2 x 4.4	1,530 mm ±100
ETSA190210U	20 AWG	Ø1.9 x 3.8	1,530 mm ±100
ETSA240167U	20 AWG	Ø1.9 x 3.8	1,530 mm ±100
ETSA480083U	22 AWG	Ø1.7 x 3.4	1,530 mm ±100

## AC CORD

### NORTH AMERICAN INPUT CABLE

units: mm

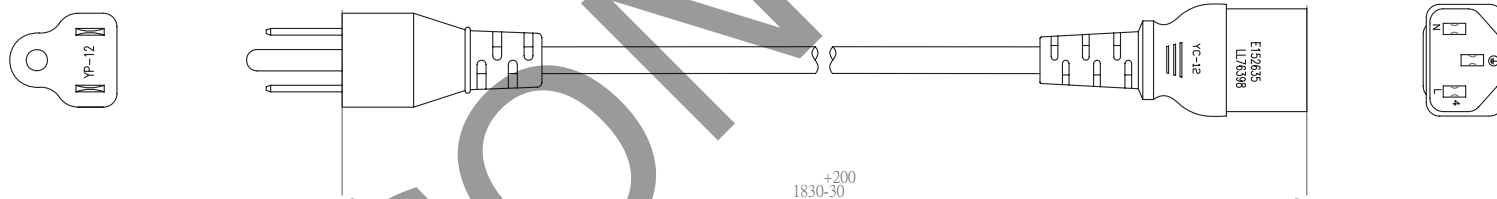

### EUROPEAN INPUT CABLE

units: mm

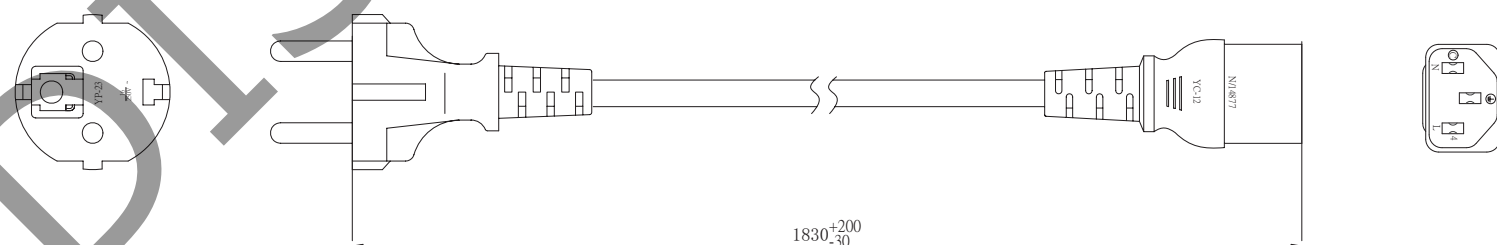

## AC CORD (CONTINUED)

### UNITED KINGDOM INPUT CABLE

units: mm

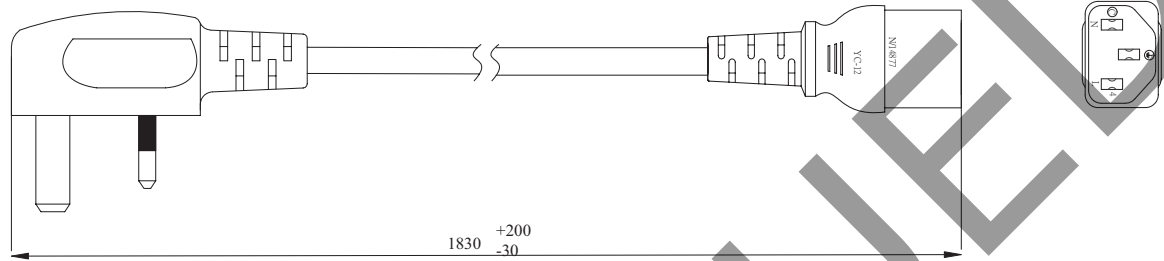

### AUSTRALIAN INPUT CABLE

units: mm

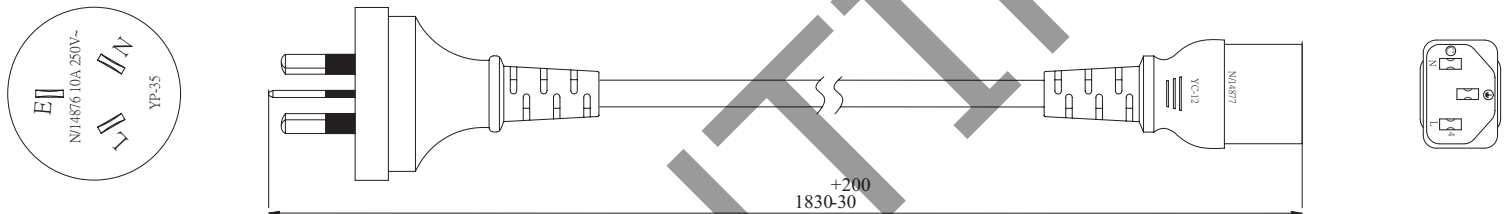

### CHINA INPUT CABLE

units: mm

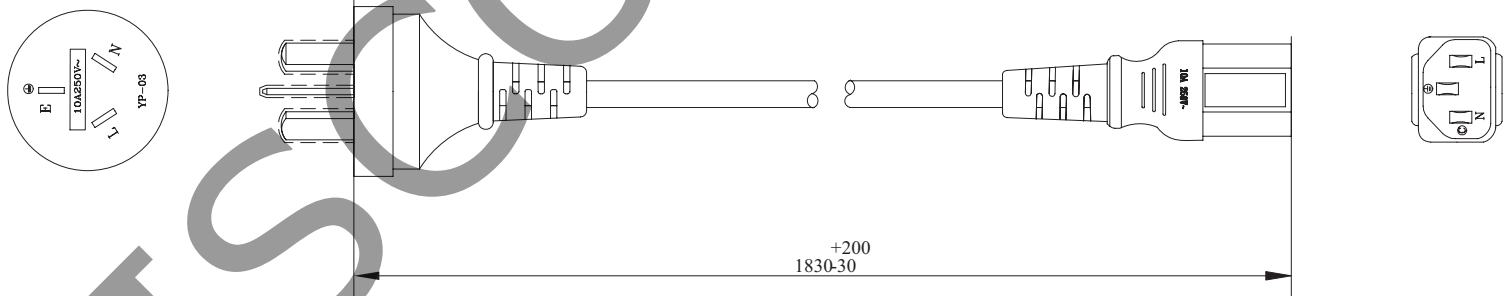

### SOUTH KOREA INPUT CABLE

units: mm

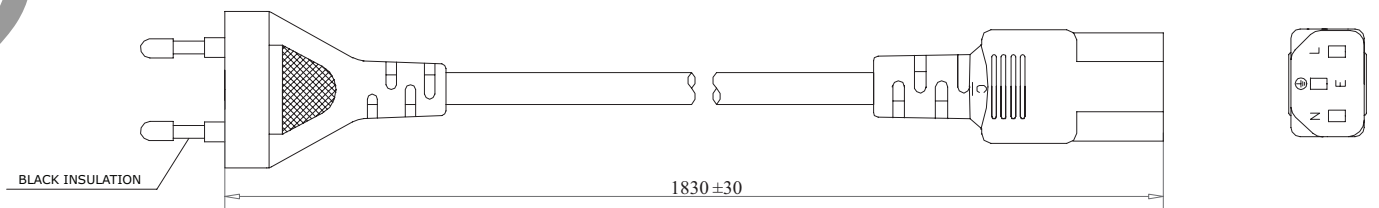

## AC CORD (CONTINUED)

### BRAZIL INPUT CABLE

units: mm

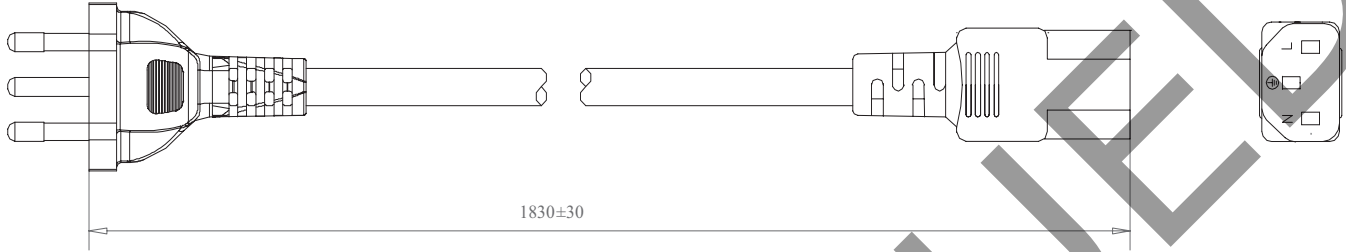

### SOUTH AFRICA INPUT CABLE

units: mm

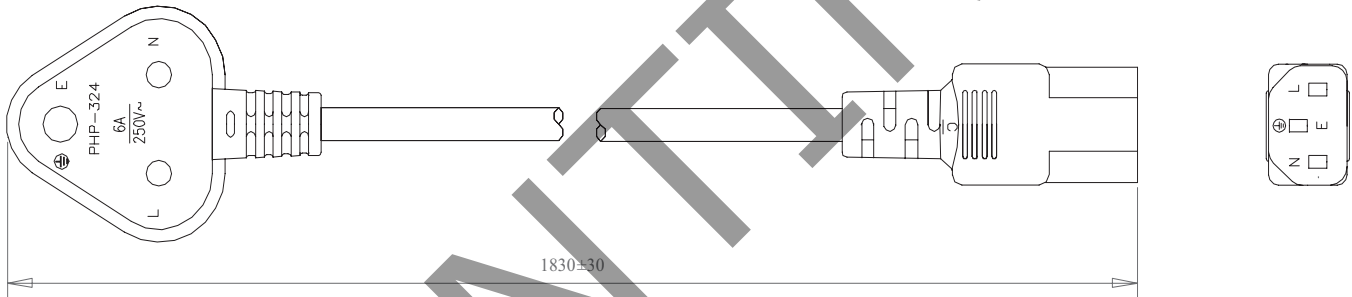

### JAPAN INPUT CABLE

units: mm

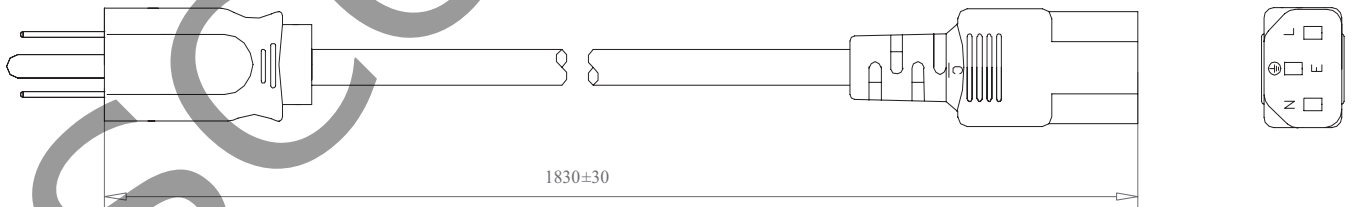

## OUTPUT PLUG OPTIONS

### 3.5 mm Phono Plug

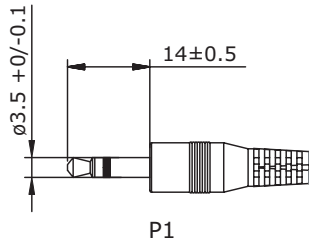

P1

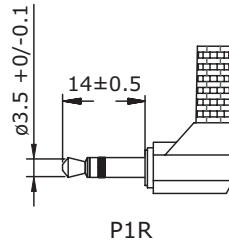

P1R

\*Tip positive

### Standard DC Plug

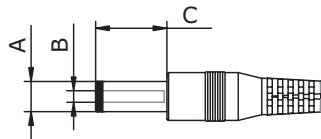

Standard PX

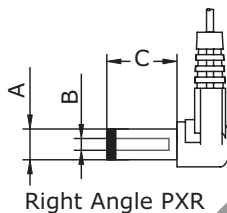

Right Angle PXR

	A	B	C	Unit
P5/P5R	5.5	2.1	9.5	mm
P6/P6R	5.5	2.5	9.5	mm
P7/P7R	3.5	1.35	9.5	mm
P8/P8R	3.8	1.35	9.5	mm
P9/P9R	3.8	1.05	9.5	mm

### Locking DC Plug

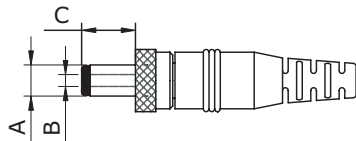

	A	B	C	Unit
P10	5.5	2.1	9.5	mm
P11	5.5	2.5	9.5	mm

### EIAJ Plugs

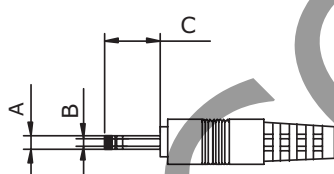

Standard PXX

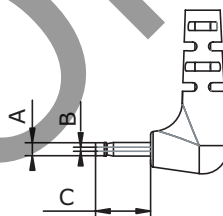

Right Angle PXXR

	EIAJ	A	B	C	D	Unit
P12/P12R	EIAJ-1	2.35	0.7	9.5	NA	mm
P13/P13R	EIAJ-2	4.0	1.7	9.5	5.0	mm
P14/P14R	EIAJ-3	4.75	1.7	9.5	5.0	mm

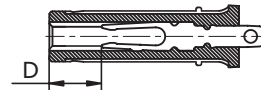

### Stripped and Tinned

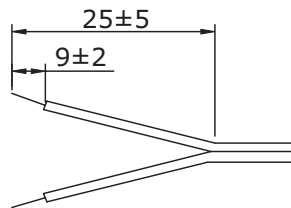

### DC PLUG TYPE

#### PXX XX

Plug Type:  
PXX = See above plug options  
ST = Stripped and Tinned

Plug Angle:  
"blank" = Straight  
R = Right Angle

Plug Polarity:  
P = Center Positive



N = Center Negative



\*Contact CUI for additional plug options

## REVISION HISTORY

rev.	description	date
1.0	initial release	12/05/2011
1.01	updated P7/P7R B dimension	03/14/2012
1.02	V-Infinity branding removed, ac cord drawing updated, safety and EMI/EMC data updated	08/21/2012
1.03	updated series number	11/20/2012
1.04	added ac cord options	11/14/2014

The revision history provided is for informational purposes only and is believed to be accurate.

This device complies with part 15 of the FCC Rules. Operation is subject to the following two conditions:

- (1) This device may not cause harmful interference, and
- (2) this device must accept any interference received, including interference that may cause undesired operation.

CUI offers a one (1) year limited warranty. Complete warranty information is listed on our website.

CUI reserves the right to make changes to the product at any time without notice. Information provided by CUI is believed to be accurate and reliable. However, no responsibility is assumed by CUI for its use, nor for any infringements of patents or other rights of third parties which may result from its use.

CUI products are not authorized or warranted for use as critical components in equipment that requires an extremely high level of reliability. A critical component is any component of a life support device or system whose failure to perform can be reasonably expected to cause the failure of the life support device or system, or to affect its safety or effectiveness.



**Headquarters**  
20050 SW 112th Ave.  
Tualatin, OR 97062  
**800.275.4899**

Fax 503.612.2383  
**cui.com**  
techsupport@cui.com