

SERIES: VASD2-DIP | DESCRIPTION: DC-DC CONVERTER
FEATURES

- 2 W isolated output
- industry standard 14 pin DIP package
- dual unregulated outputs
- 1,000 V isolation
- short circuit protection
- wide temperature (-40~85°C)
- efficiency up to 87%



MODEL	input voltage		output voltage (Vdc)	output current		output power max (W)	ripple and noise ¹ max (mVp-p)	efficiency typ (%)
	typ (Vdc)	range (Vdc)		min (mA)	max (mA)			
VASD2-S5-D5-DIP	5	4.5~5.5	±5	±20	±200	2	150	82
VASD2-S5-D9-DIP	5	4.5~5.5	±9	±12	±111	2	150	83
VASD2-S5-D12-DIP	5	4.5~5.5	±12	±5	±83	2	150	85
VASD2-S5-D15-DIP	5	4.5~5.5	±15	±7	±67	2	150	85
VASD2-S12-D5-DIP	12	10.8~13.2	±5	±20	±200	2	150	83
VASD2-S12-D9-DIP	12	10.8~13.2	±9	±12	±111	2	150	84
VASD2-S12-D12-DIP	12	10.8~13.2	±12	±5	±83	2	150	86
VASD2-S12-D15-DIP	12	10.8~13.2	±15	±7	±67	2	150	86
VASD2-S24-D5-DIP	24	21.6~26.4	±5	±20	±200	2	150	84
VASD2-S24-D9-DIP	24	21.6~26.4	±9	±12	±111	2	150	85
VASD2-S24-D12-DIP	24	21.6~26.4	±12	±5	±83	2	150	87
VASD2-S24-D15-DIP	24	21.6~26.4	±15	±7	±67	2	150	87

Notes: 1. ripple and noise are measured at 20 MHz BW

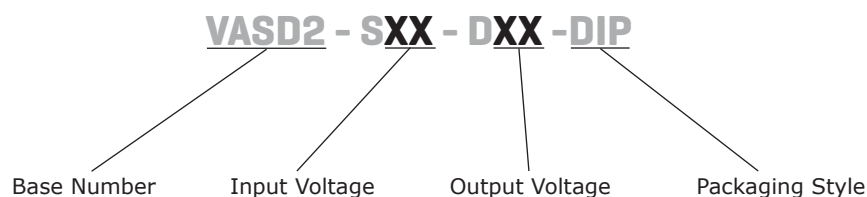
PART NUMBER KEY

INPUT

parameter	conditions/description	min	typ	max	units
operating input voltage	5 V model	4.5	5	5.5	Vdc
	12 V model	10.8	12	13.2	Vdc
	24 V model	21.6	24	26.4	Vdc
surge voltage	1 second max.	3.3V model	-0.7	5	Vdc
		5 V model	-0.7	9	Vdc
		12 V model	-0.7	18	Vdc
		15V model	-0.7	21	Vdc
		24 V model	-0.7	30	Vdc
reverse polarity input current ¹				0.4	A
input filter	C filter				

Notes: 1. If the product reverse did not seek to limit current, may result in injury or permanent damage, testing is not recommended

OUTPUT

parameter	conditions/description	min	typ	max	units
line regulation	for Vin change of 1%			1.2	%
load regulation	measured from 10% load to full load	3.3V model	12	20	%
		5 V model	12.8	15	%
		12 V model	8.3	15	%
		15V model	6.8	15	%
		24 V model	6.3	15	%
voltage accuracy	see derating curves				
switching frequency	100% load, input voltage range		75		kHz
temperature coefficient			±0.03		%/°C

PROTECTIONS

parameter	conditions/description	min	typ	max	units
short circuit protection				1	s

SAFETY AND COMPLIANCE

parameter	conditions/description	min	typ	max	units
isolation voltage	for 1 minute at 1 mA max.	1,000			Vdc
isolation resistance	at 500 Vdc	1,000			MΩ
safety approvals	UL				
MTBF		3,500,000			hours
RoHS compliant	yes				

ENVIRONMENTAL

parameter	conditions/description	min	typ	max	units
operating temperature		-40		85	°C
storage temperature		-55		125	°C
storage humidity	non-condensing			95	%
temperature rise	at full load		15	25	°C
lead temperature	1.5 mm from case for 10 seconds			300	°C

DERATING CURVES

1. output power vs. ambient temperature

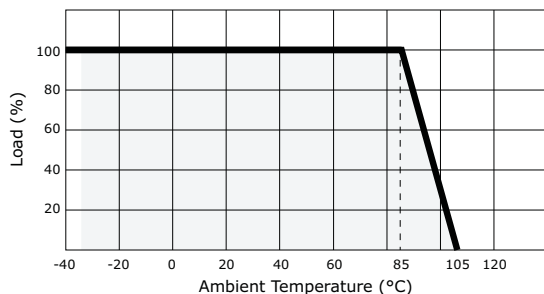

2. output voltage vs. output current

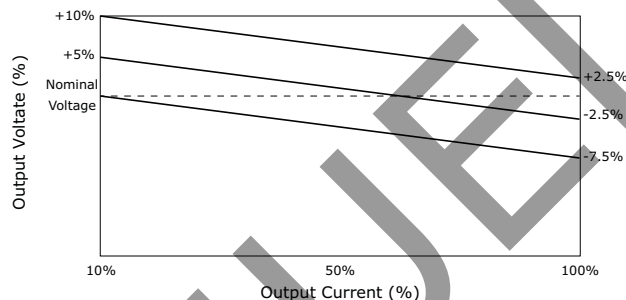

MECHANICAL

parameter	conditions/description	min	typ	max	units
dimensions	0.803 x 0.394 x 0.323 (20.40 x 10.00 x 8.20 mm)				inch
case material	plastic (UL94-V0)				
weight			2.8		g

MECHANICAL DRAWING

units: mm
 tolerance: ±0.25mm
 pin section tolerance: ±0.10mm

Side View

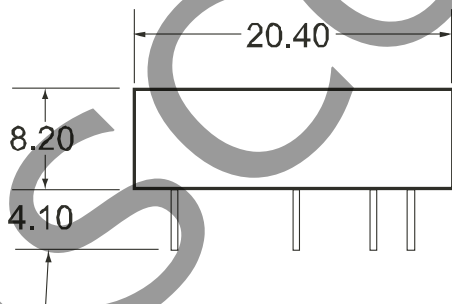

Bottom View

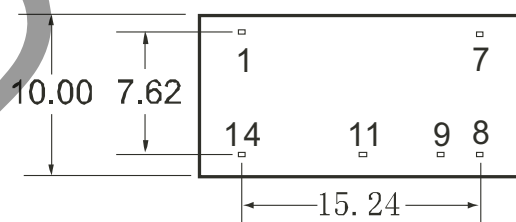

PIN CONNECTIONS	
PIN	FUNCTION
1	-Vin
7	NC
8	COM
9	+Vo
11	-Vo
14	+Vin

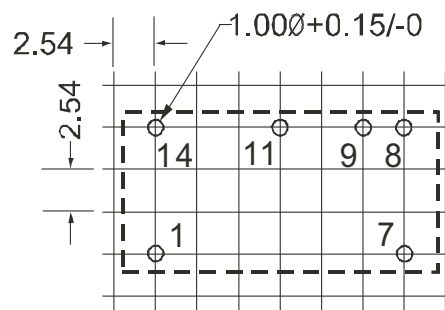

APPLICATION NOTES

1. Input filtering

To reduce the reflected ripple current and minimize EMI, especially when the converter input is more than 2" away from the DC source, it is recommended to connect a low ESR electrolytic capacitor between V_{in} and Gnd. The values suggested are as shown in Table 1. If additional filtering is required, the capacitance may be increased, or expanded to an LC network as shown in Figure 1.

Table 1

Input Voltage	External Input Capacitance
5 V	4.7 μ F
12 V	2.2 μ F
24 V	1.0 μ F



Figure 1

2. Output filtering

An output capacitor is needed to meet output ripple requirements as shown in Table 2. Output capacitance may be increased for additional filtering, but should not exceed 10 μ F or expanded to an LC network as in Figure 1.

Table 2

Output Voltage	External Input Capacitance
5 V	4.7 μ F
9 V	2.2 μ F
12 V	1.0 μ F

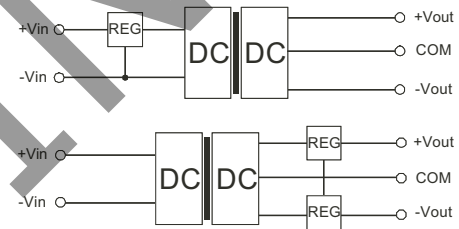

Figure 2

3. Minimum loading

The converter needs a minimum of 10% loading to maintain output regulation. Operation under no-load conditions will not cause immediate damages but may reduce reliability, and cause performance not to meet specifications.

4. Regulation

With a semi-regulated design, the converter's output voltage varies with load current and will change proportionally to the input voltage. If regulated output is needed, an external regulator can be used as shown in Figure 2.

5. Protection

The converter has minimal protection against input over-voltage or output over-load, and may be permanently damaged if exposed to these conditions. An input clamping device can be used for input voltage limiting. An input fuse or an output fuse can also be used to protect against over-loading.

6. Dual outputs used as a single output

The +Vout and -Vout can be used to obtain a single output that is the sum of the two outputs. In this case, the COM pin shouldn't be used.

7. External Regulator

An external 3-terminal regulator can be connected to the output of the converter to achieve full regulation. Make sure the converter's output voltage provides sufficient head room for the regulator. An additional benefit is that the built-in protection features in the regulator, such as OCP, OTP, etc, will protect the converter also. In a complimentary supply, a negative output regulator must be used to achieve the negative regulated output.

REVISION HISTORY

rev.	description	date
1.0	initial release	12/11/2007
1.01	new template applied	09/04/2009
1.02	new template applied, V-Infinity branding removed	09/04/2012

The revision history provided is for informational purposes only and is believed to be accurate.



Headquarters
20050 SW 112th Ave.
Tualatin, OR 97062
800.275.4899

Fax 503.612.2383
cui.com
techsupport@cui.com

CUI offers a two (2) year limited warranty. Complete warranty information is listed on our website.

CUI reserves the right to make changes to the product at any time without notice. Information provided by CUI is believed to be accurate and reliable. However, no responsibility is assumed by CUI for its use, nor for any infringements of patents or other rights of third parties which may result from its use.

CUI products are not authorized or warranted for use as critical components in equipment that requires an extremely high level of reliability. A critical component is any component of a life support device or system whose failure to perform can be reasonably expected to cause the failure of the life support device or system, or to affect its safety or effectiveness.