

SERIES: VBT2-SMT | DESCRIPTION: DC-DC CONVERTER
FEATURES

- 2 W isolated output
- industry standard 14 pin SMT package
- single unregulated outputs
- 1,000 V isolation
- short circuit protection
- wide temperature (-40~85°C)
- efficiency up to 85%

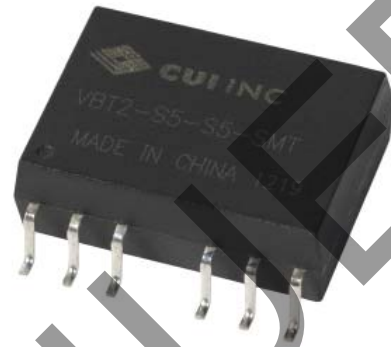

MODEL	input voltage		output voltage (Vdc)	output current		output power max (W)	ripple and noise ¹ max (mVp-p)	efficiency typ (%)
	typ (Vdc)	range (Vdc)		min (mA)	max (mA)			
VBT2-S5-S5-SMT	5	4.5~5.5	5	40	400	2	150	80
VBT2-S5-S9-SMT	5	4.5~5.5	9	23	222	2	150	82
VBT2-S5-S12-SMT	5	4.5~5.5	12	17	167	2	150	84
VBT2-S5-S15-SMT	5	4.5~5.5	15	14	133	2	150	84
VBT2-S12-S5-SMT	12	10.8~13.2	5	40	400	2	150	82
VBT2-S12-S9-SMT	12	10.8~13.2	9	23	222	2	150	83
VBT2-S12-S12-SMT	12	10.8~13.2	12	17	167	2	150	85
VBT2-S12-S15-SMT	12	10.8~13.2	15	14	133	2	150	85

Notes: 1. ripple and noise are measured at 20 MHz BW

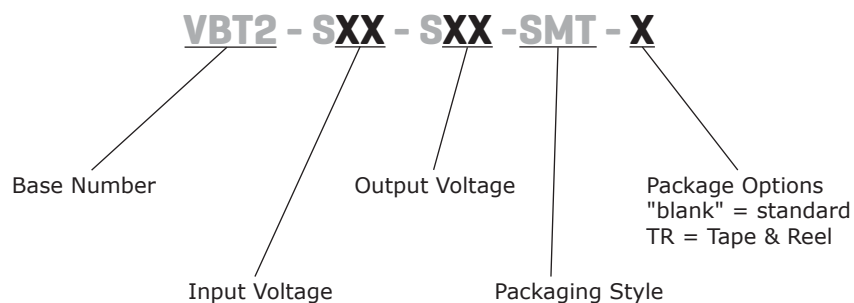
PART NUMBER KEY

INPUT

parameter	conditions/description	min	typ	max	units
operating input voltage	5 V model	4.5	5	5.5	Vdc
	12 V model	10.8	12	13.2	Vdc
input surge voltage	1 s max. 5 V model 12 V model	-0.7 -0.7		9 18	Vdc Vdc
input filter	C filter				

OUTPUT

parameter	conditions/description	min	typ	max	units
line regulation	for Vin change of 1%			±1.2	%
load regulation	measured from 10% load to full load	5 V model	12.8	15	%
		9 V model	8.3	10	%
		12 V model	6.8	10	%
		15 V model	6.3	10	%
voltage accuracy	see derating curves				
switching frequency	100% load		70		kHz
temperature coefficient	100% load			±0.03	%/°C

PROTECTIONS

parameter	conditions/description	min	typ	max	units
short circuit protection				1	s

SAFETY AND COMPLIANCE

parameter	conditions/description	min	typ	max	units
isolation voltage	for 1 minute at 1 mA max.	1,000			Vdc
isolation resistance	at 500 Vdc	1,000			MΩ
MTBF		3,500,000			hours
RoHS compliant	yes				

ENVIRONMENTAL

parameter	conditions/description	min	typ	max	units
operating temperature		-40		85	°C
storage temperature		-55		125	°C
storage humidity	non-condensing			95	%
temperature rise	at full load		25		°C
lead temperature	1.5 mm from case for 10 seconds			300	°C

DERATING CURVES

1. output power vs. ambient temperature

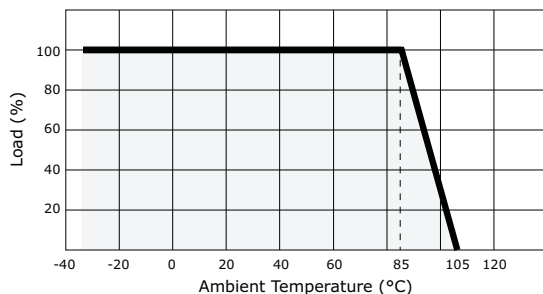

2. output voltage vs. output current

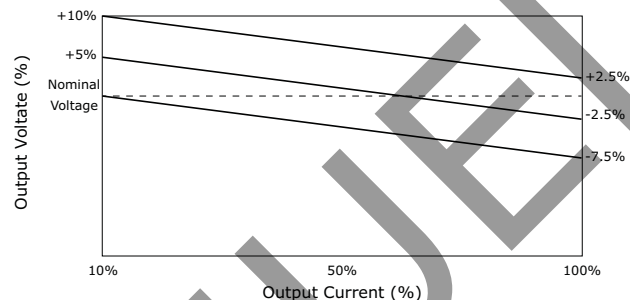

MECHANICAL

parameter	conditions/description	min	typ	max	units
dimensions	0.700 x 0.500 x 0.236 (17.78 x 12.70 x 6.00 mm)				inch
case material	plastic (UL94-V0)				
weight			2.1		g

MECHANICAL DRAWING

units: mm [inches]
 tolerance: ± 0.25 [± 0.010]
 pin section tolerance: ± 0.10 mm [± 0.004]

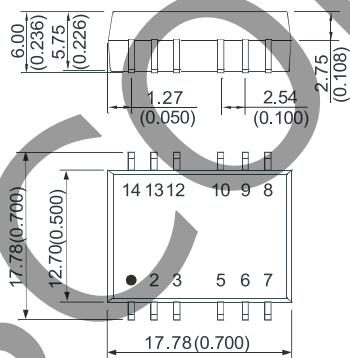

First Angle Projection

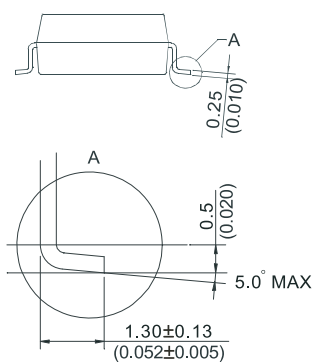

RECOMMENDED FOOTPRINT
 Bottom view, grid: 2.54mm (0.1inch)

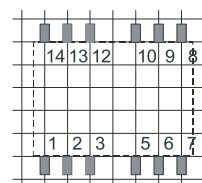

PIN CONNECTIONS	
PIN	FUNCTION
1	GND
2	+Vin
5	NC
6	0 V
7	+Vo
10	NC
others	NC

APPLICATION NOTES

1. Requirement on Output Load

In order to ensure the product operates efficiently and reliably, make sure the specified range of input voltage is not exceeded and the minimum output load is not less than 10% load. If the actual load is less than the specified minimum load, the output ripple may increase sharply while its efficiency and reliability will reduce greatly. If the actual output power is very small, please add an appropriate resistor as extra loading.

2. Overload Protection

Under normal operating conditions, the output circuit of these products has no protection against over-current and short-circuits. The simplest method is to connect a self-recovery fuse in series at the input end or add a circuit breaker to the circuit.

3. Filtering

In some circuits which are sensitive to noise and ripple, a filtering capacitor may be added to the DC/DC output end and input end to reduce the noise and ripple. However, the capacitance of the output filter capacitor must be proper. If the capacitance is too big, a startup problem might arise. For every channel of output, provided the safe and reliable operation is ensured, the greatest capacitance of its filter capacitor sees the external capacitor table. To get an extremely low ripple, an "LC" filtering network may be connected to the input and output ends of the DC/DC converter, which may produce a more significant filtering effect. It should also be noted that the inductance and the frequency of the "LC" filtering network should be staggered with the DC/DC frequency to avoid mutual interference (Figure 1).

Figure 1

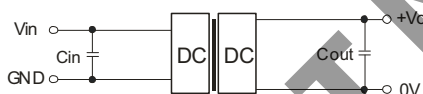

4. Output Voltage Regulation and Over-voltage Protection Circuit

The simplest device for output voltage regulation, over-voltage and over-current protection is a linear voltage regulator with overheat protection that is connected to the input or output end in series (Figure 2).

Figure 2



5. External Capacitor Table

It is not recommended to connect any external capacitor in the application field with less than 0.5 W output.

Table 1

Vin (Vdc)	Cin (μF)	Vout (Vdc)	Cout (μF)
5	4.7	5	10
12	2.2	9	4.7
--	--	12	2.2
--	--	15	1

REVISION HISTORY

rev.	description	date
1.0	initial release	02/08/2008
1.01	new template applied	04/20/2012
1.02	V-Infinity branding removed	09/06/2012
1.03	added TR package option	11/01/2012

The revision history provided is for informational purposes only and is believed to be accurate.



Headquarters
20050 SW 112th Ave.
Tualatin, OR 97062
800.275.4899

Fax 503.612.2383
cui.com
techsupport@cui.com

CUI offers a two (2) year limited warranty. Complete warranty information is listed on our website.

CUI reserves the right to make changes to the product at any time without notice. Information provided by CUI is believed to be accurate and reliable. However, no responsibility is assumed by CUI for its use, nor for any infringements of patents or other rights of third parties which may result from its use.

CUI products are not authorized or warranted for use as critical components in equipment that requires an extremely high level of reliability. A critical component is any component of a life support device or system whose failure to perform can be reasonably expected to cause the failure of the life support device or system, or to affect its safety or effectiveness.