

SERIES: VFSD1-SIP | DESCRIPTION: DC-DC CONVERTER
FEATURES

- 1 W isolated output
- industry standard pinout
- unregulated
- single output (5~24 V)
- small footprint
- 3,000 V isolation
- short circuit protection
- temperature range (-40~85°C)
- efficiency up to 81%

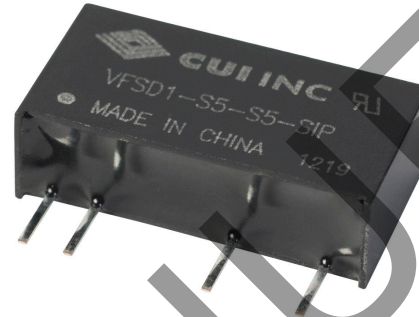

MODEL	input voltage		output voltage (Vdc)	output current		output power max (W)	ripple noise max (mVp-p)	efficiency typ (%)
	typ (Vdc)	range (Vdc)		min (mA)	max (mA)			
VFSD1-S3.3-S3.3-SIP	3.3	3.0 ~ 3.6	3.3	31	303	1	100	69
VFSD1-S3.3-S5-SIP	3.3	3.0 ~ 3.6	5	20	200	1	100	74
VFSD1-S5-S5-SIP	5	4.5 ~ 5.5	5	20	200	1	30	80
VFSD1-S5-S12-SIP	5	4.5 ~ 5.5	12	9	83	1	30	80
VFSD1-S5-S15-SIP	5	4.5 ~ 5.5	15	7	67	1	60	81
VFSD1-S5-S24-SIP	5	4.5 ~ 5.5	24	5	42	1	60	81
VFSD1-S12-S5-SIP	12	10.8 ~ 13.2	5	20	200	1	30	80
VFSD1-S12-S12-SIP	12	10.8 ~ 13.2	12	9	83	1	30	80
VFSD1-S12-S15-SIP	12	10.8 ~ 13.2	15	7	67	1	60	81
VFSD1-S15-S5-SIP	15	13.5 ~ 16.5	5	20	200	1	30	80
VFSD1-S15-S15-SIP	15	13.5 ~ 16.5	15	7	67	1	60	81
VFSD1-S24-S5-SIP	24	21.6 ~ 26.4	5	20	200	1	30	79
VFSD1-S24-S12-SIP	24	21.6 ~ 26.4	12	9	83	1	30	81
VFSD1-S24-S15-SIP	24	21.6 ~ 26.4	15	7	67	1	60	82

Note: 1. Ripple and noise measured at 20 mHz BW

PART NUMBER KEY

VFSD1-S XX -S XX -SIP

Base Number

Input Voltage

Output Voltage

INPUT

parameter	conditions/description	min	typ	max	units
operating input voltage	5 V model	4.5	5	5.5	Vdc
	12 V model	10.8	12	13.2	Vdc
	15 V model	13.5	15	16.5	Vdc
	24 V model	21.6	24	26.4	Vdc
input surge voltage	1 second max.	-0.7		9	Vdc
		-0.7		18	Vdc
		-0.7		21	Vdc
		-0.7		30	Vdc
input filter	C filter				

OUTPUT

parameter	conditions/description	min	typ	max	units
voltage accuracy	see derating curves				
line regulation	for Vin change of $\pm 1\%$			± 1.2	%
load regulation	10 ~ 100% full load	5 V model	10	15	%
		12 V model	8	15	%
		15 V model	7	15	%
		24 V model	6	15	%
switching frequency	100% load, nominal input voltage		100	300	kHz
temperature coefficient	100% load			± 0.03	%/°C

PROTECTIONS

parameter	conditions/description	min	typ	max	units
short circuit protection	continuous, automatic recovery				

SAFETY AND COMPLIANCE

parameter	conditions/description	min	typ	max	units
isolation voltage	tested for 1 minute at 1 mA max.	3,000			Vdc
isolation resistance	at 500 Vdc	1,000			M Ω
isolation capacitance	input to output, 100 kHz / 0.1 V		20		pF
EMI/EMC	CISPR22/EN 55022 Class B, IEC/EN 61000-4-2				
RoHS compliant	yes				
MTBF	MIL-HDBK-217F, 25°C	3,500,000			hours

ENVIRONMENTAL

parameter	conditions/description	min	typ	max	units
operating temperature		-40		105	°C
storage temperature		-55		125	°C
storage humidity	non-condensing			95	%
temperature rise	100% load		25		°C
lead temperature	1.5 mm from the case for 10 seconds			300	°C

EMC RECOMMENDED CIRCUIT

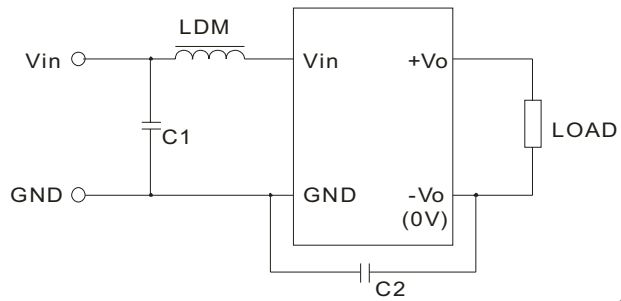

RECOMMENDED EXTERNAL CIRCUIT PARAMETERS	Vin = 5V	Vin = 12V	Vin = 15V	Vin = 24V
C1	475 k / 50 V			
LDM	6.8 μ H			
C2	---		470 pF / 2 kV	

DERATING CURVES

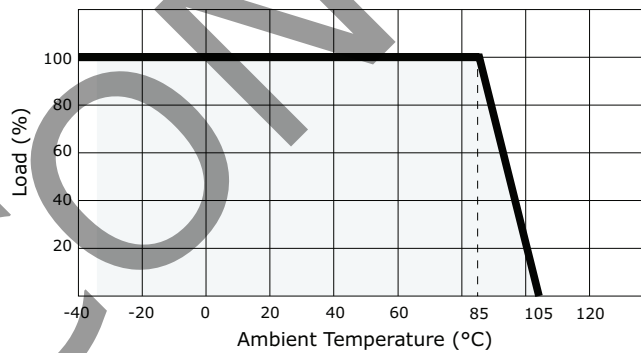

MECHANICAL

parameter	conditions/description	min	typ	max	units
dimensions	0.768 x 0.236 x 0.39 (19.50 x 6.00 x 10.0 mm)				inch
case material	Plastic (UL94-V0)				
weight			2.4		g

MECHANICAL DRAWING

units: mm [inches]
 tolerance: ± 0.25 [± 0.010]
 pin section tolerance: ± 0.10 mm [± 0.004]

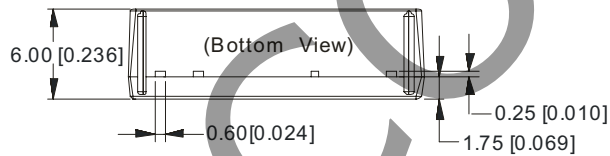
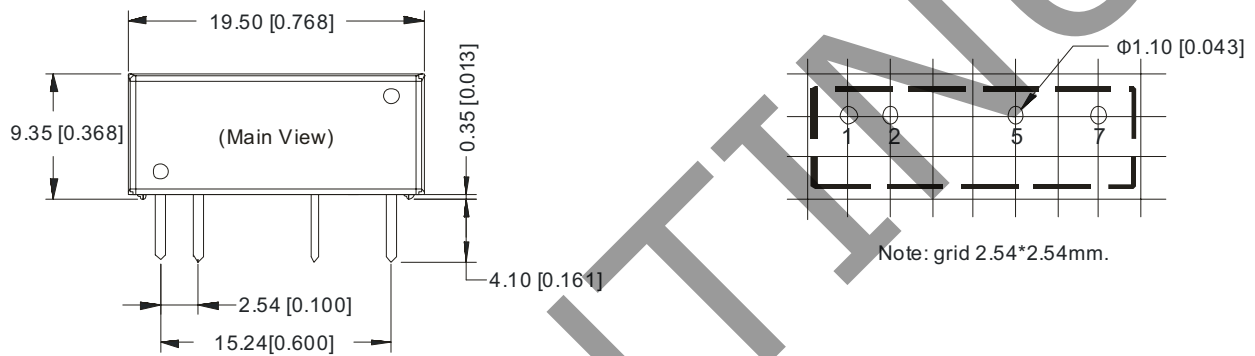

PIN CONNECTIONS	
PIN	FUNCTION
1	Vin
2	GND
5	0 V
7	+Vo

APPLICATION NOTES

1. Requirement on output load

To ensure this module can operate efficiently and reliably, During operation, the minimum output load could not be less than 10% of the full load. If the actual output power is very small, please connect a resistor with proper resistance at the output end in parallel to increase the load, or use our company's products with a lower rated output power.

2. Overload Protection

Under normal operating conditions, the output circuit of these products has no protection against overload. The simplest method is to connect a self-recovery fuse in series at the input end or add a circuit breaker to the circuit.

3. Recommended testing and application circuit

If you want to further decrease the input/output ripple, an "LC" filtering network may be connected to the input and output ends of the DC/DC converter, see (Figure 1). It should also be noted that the inductance and the frequency of the "LC" filtering network should be staggered with the DC/DC frequency to avoid mutual interference. However, the capacitance of the output filter capacitor must be proper. If the capacitance is too big, a startup problem might arise. For every channel of output, provided the safe and reliable operation is ensured, the recommended capacitance of its filter capacitor sees (Table 1).

Figure 1

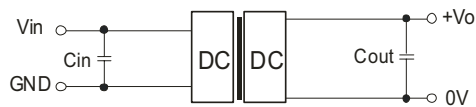

External Capacitor Table (Table 1)

Vin (Vdc)	Cin (μF)	Vout (Vdc)	Cout (μF)
5	4.7	5	10
12	2.2	9.0	4.7
15	2.2	12	2.2
24	1.0	15, 24	1.0

4. Output Voltage Regulation and Over-voltage Protection Circuit

The simplest device for output voltage regulation, over-voltage and over-current protection is a linear voltage regulator with overheat protection that is connected to the input or output end in series (Figure 2).

Figure 2

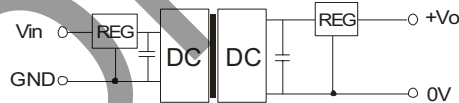

5. No parallel connection or plug and play

REVISION HISTORY

rev.	description	date
1.0	initial release	10/04/2007
1.01	updated drawings and data	05/31/2012
1.02	V-Infinity branding removed	09/05/2012
1.03	added 2 models to datasheet	01/28/2013

The revision history provided is for informational purposes only and is believed to be accurate.



Headquarters
20050 SW 112th Ave.
Tualatin, OR 97062
800.275.4899

Fax 503.612.2383
cui.com
techsupport@cui.com

CUI offers a two (2) year limited warranty. Complete warranty information is listed on our website.

CUI reserves the right to make changes to the product at any time without notice. Information provided by CUI is believed to be accurate and reliable. However, no responsibility is assumed by CUI for its use, nor for any infringements of patents or other rights of third parties which may result from its use.

CUI products are not authorized or warranted for use as critical components in equipment that requires an extremely high level of reliability. A critical component is any component of a life support device or system whose failure to perform can be reasonably expected to cause the failure of the life support device or system, or to affect its safety or effectiveness.