

**SERIES: VGDS1-SIP | DESCRIPTION: DC-DC CONVERTER**
**FEATURES**

- 1 W isolated output
- industry standard 7 pin SIP package
- dual unregulated outputs
- 6,000 V isolation
- short circuit protection
- UL safety approvals
- wide temperature (-40~105°C)
- efficiency up to 82%



MODEL	input voltage		output voltage (Vdc)	output current		output power max (W)	ripple and noise <sup>1</sup> max (mVp-p)	efficiency typ (%)	UL60950
	typ (Vdc)	range (Vdc)		min (mA)	max (mA)				
VGDS1-S5-D5-SIP	5	4.5~5.5	±5	±10	±100	1	150	78	YES
VGDS1-S5-D9-SIP	5	4.5~5.5	±9	±6	±56	1	150	79	YES
VGDS1-S5-D12-SIP	5	4.5~5.5	±12	±5	±42	1	150	79	YES
VGDS1-S5-D15-SIP	5	4.5~5.5	±15	±4	±33	1	150	79	YES
VGDS1-S12-D5-SIP	12	10.8~13.2	±5	±10	±100	1	150	80	YES
VGDS1-S12-D9-SIP	12	10.8~13.2	±9	±6	±56	1	150	82	YES
VGDS1-S12-D12-SIP	12	10.8~13.2	±12	±5	±42	1	150	81	YES
VGDS1-S12-D15-SIP	12	10.8~13.2	±15	±4	±33	1	150	82	YES
VGDS1-S15-D5-SIP	15	13.5~16.5	±5	±10	±100	1	150	80	NO
VGDS1-S15-D9-SIP	15	13.5~16.5	±9	±6	±56	1	150	75	NO
VGDS1-S15-D12-SIP	15	13.5~16.5	±12	±5	±42	1	150	78	NO
VGDS1-S15-D15-SIP	15	13.5~16.5	±15	±4	±33	1	150	81	NO
VGDS1-S24-D5-SIP	24	21.6~26.4	±5	±10	±100	1	150	72	YES
VGDS1-S24-D9-SIP	24	21.6~26.4	±9	±6	±56	1	150	76	YES
VGDS1-S24-D12-SIP	24	21.6~26.4	±12	±5	±42	1	150	80	YES
VGDS1-S24-D15-SIP	24	21.6~26.4	±15	±4	±33	1	150	78	YES

Notes: 1. ripple and noise are measured at 20 MHz BW

**PART NUMBER KEY**

**VGDS1 - SXX - DXX - SIP**

Base Number

Input Voltage

Output Voltage

Packaging Style

**INPUT**

parameter	conditions/description	min	typ	max	units
operating input voltage	5 V model	4.5	5	5.5	Vdc
	12 V model	10.8	12	13.2	Vdc
	15 V model	13.5	12	16.5	Vdc
	24 V model	21.6	24	26.4	Vdc

**OUTPUT**

parameter	conditions/description	min	typ	max	units
output power		0.1		1	W
line regulation	for Vin change of 1%			±1.2	%
load regulation	measured from 10% load to full load		10	15	%
voltage accuracy	see derating curves				
switching frequency	5 V input models	35	40	65	kHz
	all other models	35	50	65	kHz
temperature coefficient			±0.03		%/°C

**PROTECTIONS**

parameter	conditions/description	min	typ	max	units
short circuit protection	continuous			1	s

**SAFETY AND COMPLIANCE**

parameter	conditions/description	min	typ	max	units
isolation voltage	for 1 minute at 1 mA max.	6,000			Vdc
isolation resistance	at 500 Vdc	1,000			MΩ
safety approvals	UL 60950 (E222736)				
MTBF		3,500,000			hours
RoHS compliant	yes				

**ENVIRONMENTAL**

parameter	conditions/description	min	typ	max	units
operating temperature	see derating curve	-40		105	°C
storage temperature		-55		125	°C
storage humidity	non-condensing			95	%
temperature rise	at full load		15	25	°C
lead temperature	1.5 mm from case for 10 seconds			300	°C

## DERATING CURVES

1. output power vs. ambient temperature

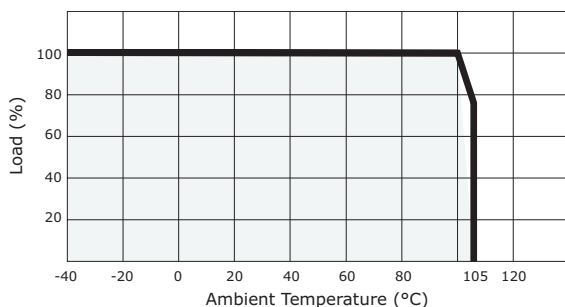

2. output voltage vs. output current

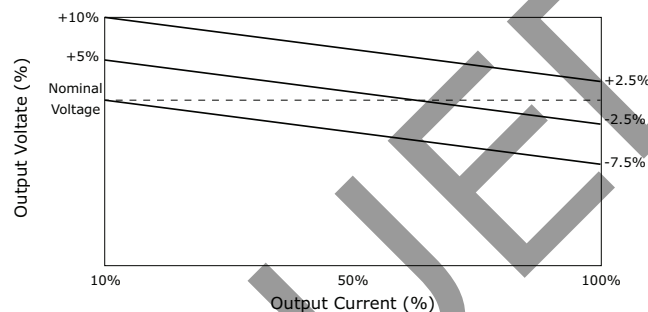

## MECHANICAL

parameter	conditions/description	min	typ	max	units
dimensions	19.5 x 9.80 x 12.5 (0.768 x 0.386 x 0.492 inch)				mm
case material	plastic (UL94-V0)				
weight			4.3		g

## MECHANICAL DRAWING

units: mm [inch]  
 tolerance: ±0.25  
 pin section tolerance: ±0.10 mm

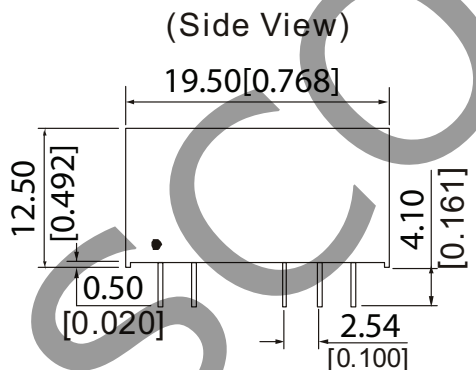

(Bottom View)

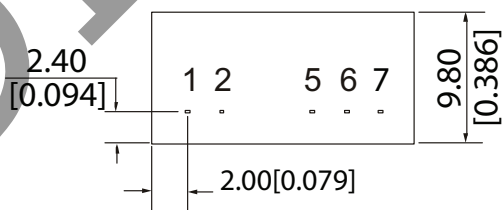

First Angle Projection

RECOMMENDED FOOTPRINT  
 Top view, grid: 2.54mm (0.1inch)  
 diameter: 1.00mm (0.039inch)

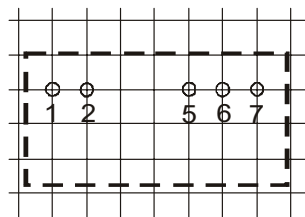

PIN CONNECTIONS	
PIN	FUNCTION
1	+Vin
2	-Vin
5	-Vo
6	COM
7	+Vo

## APPLICATION NOTES

### 1. Input filtering

To reduce the reflected ripple current and minimize EMI, especially when the converter input is more than 2" away from the DC source, it is recommended to connect a low ESR electrolytic capacitor between Vin and Gnd. The values suggested are as shown in Table 1. If additional filtering is required, the capacitance may be increased, or expanded to an LC network as shown in Figure 1.

Table 1

Input Voltage	External Input Capacitance
5 V	4.7 $\mu$ F
12 V	2.2 $\mu$ F
15 V	2.2 $\mu$ F
24 V	1.0 $\mu$ F



Figure 1

### 2. Output filtering

An output capacitor is needed to meet output ripple requirements as shown in Table 2. Output capacitance may be increased for additional filtering, but should not exceed 10 $\mu$ F or expanded to an LC network as in Figure 1.

Table 2

Output Voltage	External Input Capacitance
5 V	4.7 $\mu$ F
9 V	2.2 $\mu$ F
12 V	1.0 $\mu$ F
15 V	0.47 $\mu$ F
24 V	0.33 $\mu$ F

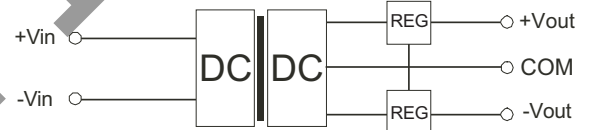

Figure 2

### 3. Minimum loading

The converter needs a minimum of 10% loading to maintain output regulation. Operation under no-load conditions will not cause immediate damages but may reduce reliability, and cause performance not to meet specifications.

### 4. Regulation

With a semi-regulated design, the converter's output voltage varies with load current and will change proportionally to the input voltage. If regulated output is needed, an external regulator can be used as shown in Figure 2.

### 5. Protection

The converter has minimal protection against input over-voltage or output over-load, and may be permanently damaged if exposed to these conditions. An input clamping device can be used for input voltage limiting. An input fuse or an output fuse can also be used to protect against over-loading.

### 6. Dual outputs used as a single output

The +Vout and -Vout can be used to obtain a single output that is the sum of the two outputs. In this case, the COM pin shouldn't be used.

### 7. External Regulator

An external 3-terminal regulator can be connected to the output of the converter to achieve full regulation. Make sure the converter's output voltage provides sufficient head room for the regulator. An additional benefit is that the built-in protection features in the regulator, such as OCP, OTP, etc, will protect the converter also. In a complimentary supply, a negative output regulator must be used to achieve the negative regulated output.

## REVISION HISTORY

rev.	description	date
1.0	initial release	06/20/2006
1.01	new template applied, V-Infinity branding removed	09/07/2012
1.02	5 V input models changed efficiency, switching frequency, short circuit protection, and operating temperature	06/17/2013

The revision history provided is for informational purposes only and is believed to be accurate.



**Headquarters**  
20050 SW 112th Ave.  
Tualatin, OR 97062  
**800.275.4899**

Fax 503.612.2383  
**cui.com**  
techsupport@cui.com

CUI offers a two (2) year limited warranty. Complete warranty information is listed on our website.

CUI reserves the right to make changes to the product at any time without notice. Information provided by CUI is believed to be accurate and reliable. However, no responsibility is assumed by CUI for its use, nor for any infringements of patents or other rights of third parties which may result from its use.

CUI products are not authorized or warranted for use as critical components in equipment that requires an extremely high level of reliability. A critical component is any component of a life support device or system whose failure to perform can be reasonably expected to cause the failure of the life support device or system, or to affect its safety or effectiveness.