



Part No: CEM-14R06CT

Description: magnetic buzzer

Date: 9/12/2006

Unit: mm

Page No: 1 of 5



Specifications

Rated voltage	1.5 Vo-p	
Operating voltage	1.0 - 1.7 Vo-p	
Mean current	40 mA max.	
Coil resistance	16 ±2.4 Ω	Applying rated voltage, 2800 Hz square wave, ½ duty
Sound output	Min. 85 (Typical 91) dBA	Distance at 10cm (A-weight free air). Applying rated voltage of 2800 Hz, square wave, ½ duty.
Rated frequency	2,800 Hz	
Operating temperature	-30 ~ +70° C	
Storage temperature	-40 ~ +85° C	
Dimensions	ø12.0 x H10.0 mm	See attached drawing
Weight	1.6 g	
Material	PBT (Black)	
Terminal	Pin type (Au Plating)	See attached drawing
RoHS	yes	

Frequency Response Curve

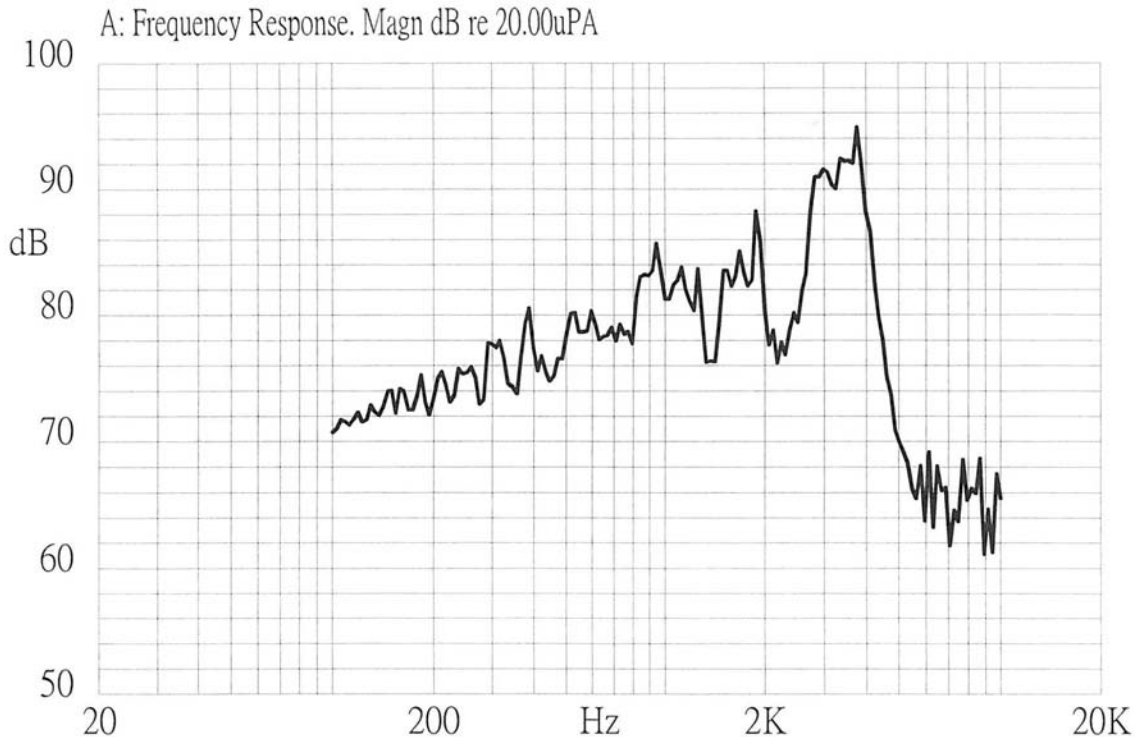



Part No: CEM-14R06CT

Description: magnetic buzzer

Date: 9/12/2006

Unit: mm

Page No: 2 of 5

Appearance Drawing

Tolerance: ± 0.5

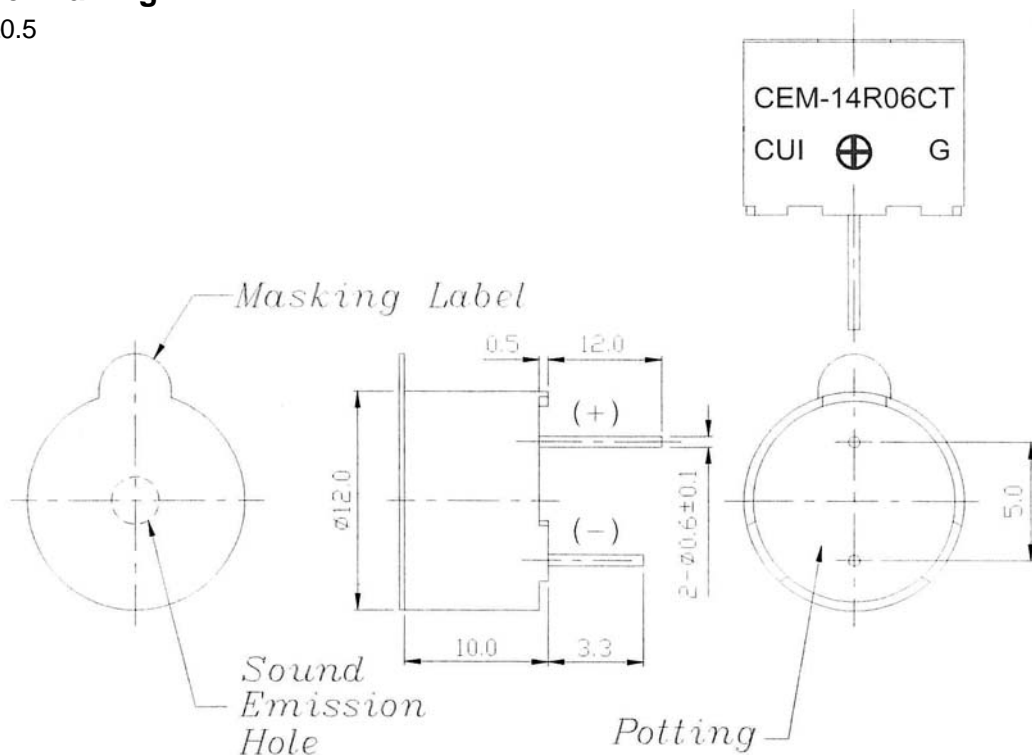

Measurement Method

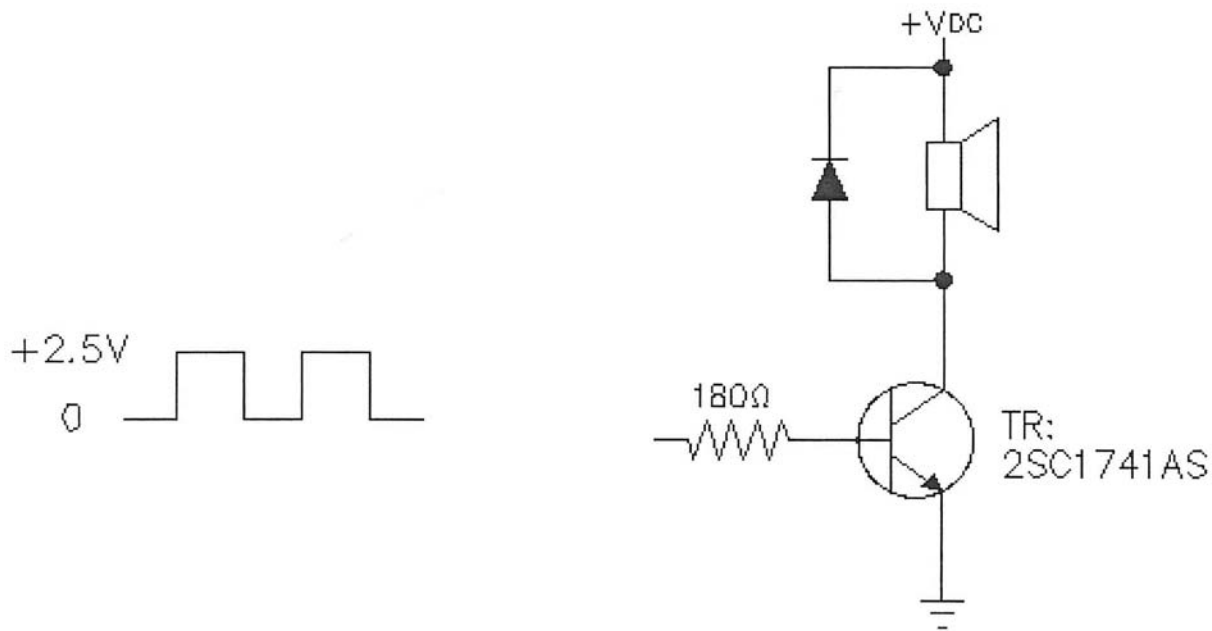



Part No: CEM-14R06CT

Description: magnetic buzzer

Date: 9/12/2006

Unit: mm

Page No: 3 of 5

Mechanical Characteristics

Item	Test Condition	Evaluation Standard
Solderability ¹	Lead terminals are immersed in rosin for 5 seconds and then immersed in solder bath of 270 ±5°C for 3 ±1 seconds.	90% min. lead terminals should be wet with solder. (Except the edge of the terminal.)
Soldering Heat Resistance	Lead terminals are immersed up to 1.5 mm from the buzzer's body in solder bath of 260 ±5°C for 3 ±1 seconds.	No in interference in operation.
Terminal Mechanical Strength	Apply a force of 9.8 N (1.0 kg) to each terminal in each axial direction.	No damage or cutting off.
Vibration	The buzzer will be measured after applying a vibration amplitude of 1.5mm with 10 to 55 Hz band of vibration frequency to each of the 3 perpendicular directions for 2 hours.	After the test, the part should meet specifications without any damage to the appearance and the SPL should be within ±10 dBA of the initial measurement.
Drop Test	The part is to be dropped from a height of 75 cm onto a 40 mm thick wooden board 3 times in 3 axis (X, Y, Z) for a total of 9 drops.	

Notes: 1. Not recommended for wave soldering

Environment Test

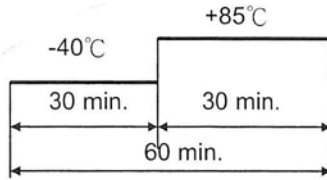
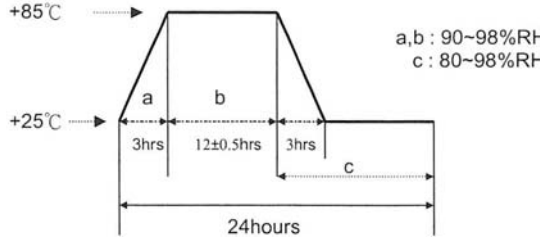
Item	Test Condition	Evaluation Standard
High temp. test	The part will be subjected to +85°C for 96 hours.	After the test, the part should meet specifications without any damage to the appearance or performance except SPL. After 4 hours at 25°C, the SPL should be within ±10 dBA of the initial measurement.
Low temp. test	The part will be subjected to -40°C for 96 hours	
Thermal shock	The part will be subjected to 10 cycles. One cycle will consist of: 	
Temp./Humidity cycle	The part shall be subjected to 10 cycles. One cycle will be 24 hours and consist of: 	



Part No: CEM-14R06CT

Date: 9/12/2006

Unit: mm

Description: magnetic buzzer

Page No: 4 of 5

Reliability Tests

Item	Test Condition	Evaluation Standard
Operating (Life Test)	1. Continuous life test: The part will be subjected to 72 hours at 55°C with 1.5 V, 2800 Hz applied. 2. Intermittent life test: A duty cycle of 1 minute on, 1 minute off, a minimum of 10,000 times at room temp. (+25 ±10°C) with 1.5 V, 2800 Hz applied.	After the test, the part shall meet specifications without any damage to the appearance. After 4 hours at +25°C, the SPL should be within ±10 dBA of the initial SPL.

Test Conditions

Standard Test Condition	a) Temperature: +5 ~ +35°C	b) Humidity: 45 - 85%	c) Pressure: 860 - 1060 mbar
Judgement Test Condition	a) Temperature: +25±2°C	b) Humidity: 60 - 70%	c) Pressure: 860 - 1060 mbar



Part No: CEM-14R06CT

Date: 9/12/2006

Unit: mm

Description: magnetic buzzer

Page No: 5 of 5

Packaging

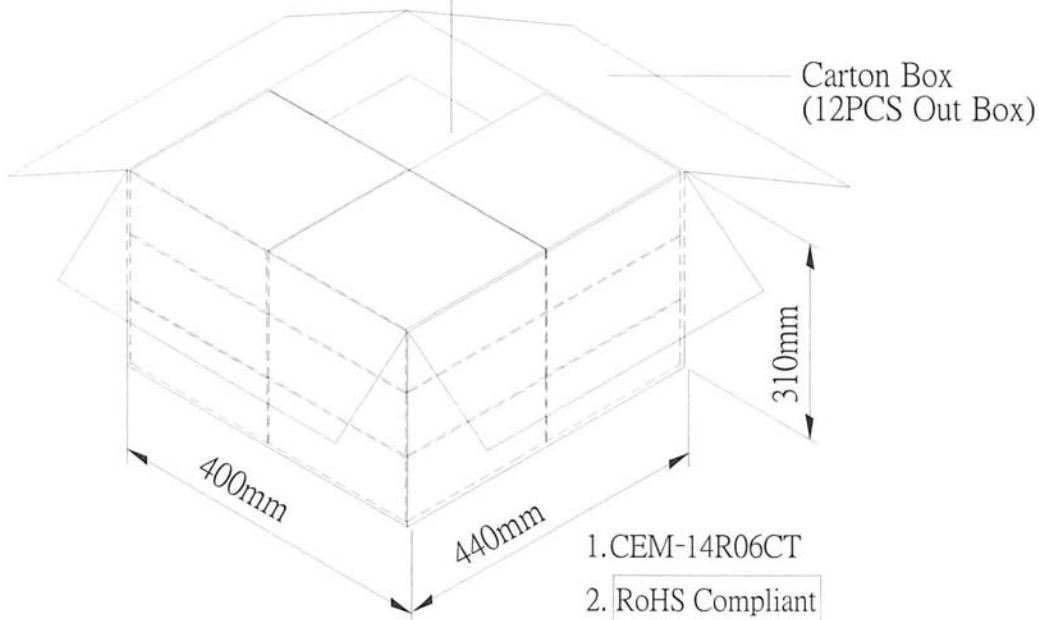
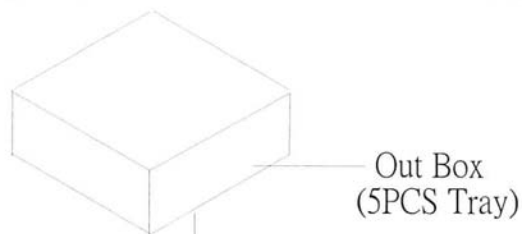
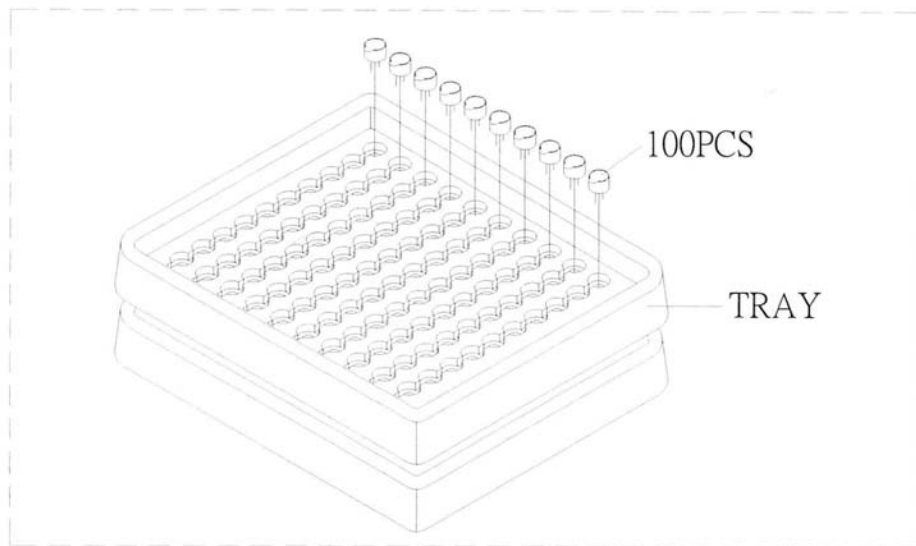

Tray	184mmx184mmx23mm	1x100PCS=100PCS
Out Box	200mmx190mmx100mm	5LAYERx100PCS=500PCS
Carton Box	440mmx400mmx310mm	500PCSx12=6,000PCS