



MODEL: CMT-5023S-SMT | **DESCRIPTION:** MAGNETIC BUZZER TRANSDUCER

FEATURES

- 5 x 5 x 2 mm
- SMT
- rated frequency of 4000 Hz



SPECIFICATIONS

| parameter | conditions/description | min | typ | max | units |
|-----------------------|---|-----|-------|-----|-------|
| rated voltage |  | | 3.0 | | Vo-p |
| operating voltage |  | 2.0 | | 4.0 | Vo-p |
| current consumption | at rated voltage, 4,000 Hz square wave, 1/2 duty | | | 110 | mA |
| rated frequency | | | 4,000 | | Hz |
| sound pressure level | at 10 cm (A-weight), rated voltage, 4,000 Hz square wave, 1/2 duty | 80 | | | dB(A) |
| coil resistance | | 9 | 12 | 15 | Ω |
| dimensions | 5.0 x 5.0 x 2.0 | | | | mm |
| weight | | | 0.35 | | g |
| material | LCP | | | | |
| terminal | SMT type (Sn plating) | | | | |
| operating temperature | | -30 | | 70 | °C |
| storage temperature | | -40 | | 85 | °C |
| RoHS | 2011/65/EU | | | | |

Notes: 1. Add suffix "-TR" to the model for tape & reel packaging
 2. All specifications measured at 5~35°C, humidity at 45~85%, under 86~106 kPa pressure, unless otherwise noted.

SOLDERABILITY

| parameter | conditions/description | min | typ | max | units |
|------------------|--|-----|-----|-----|-------|
| reflow soldering | see recommended reflow soldering profile | | | 240 | °C |

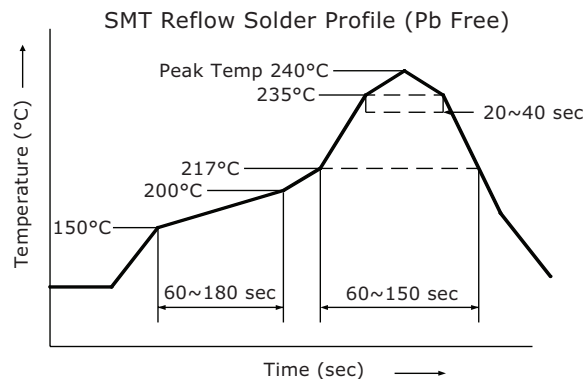

MECHANICAL DRAWING

units: mm
tolerance: ± 0.2 mm

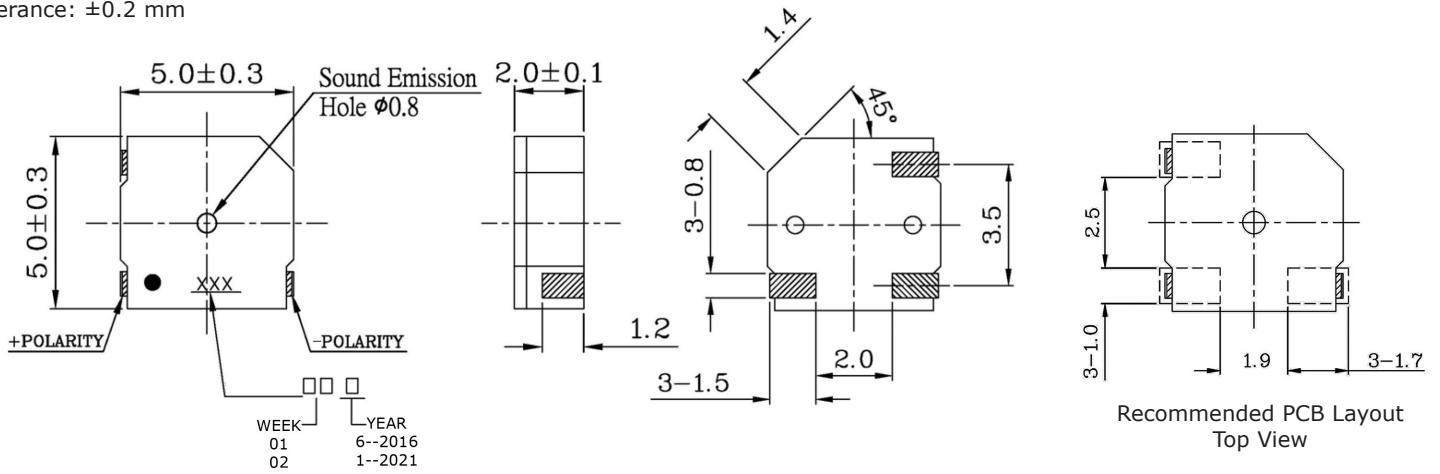

FREQUENCY RESPONSE CURVE

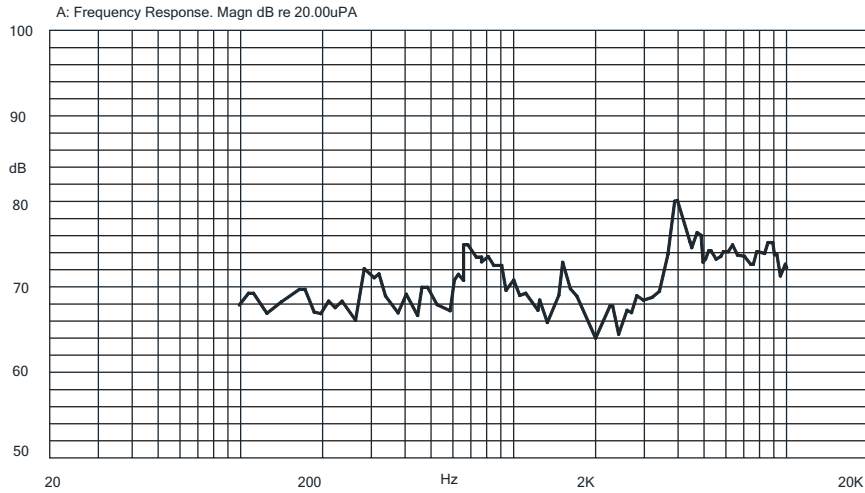

MEASUREMENT METHOD

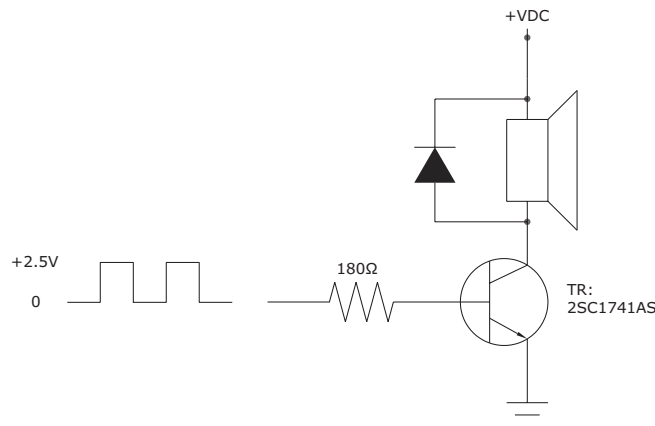

PACKAGING

units: mm

Reel Size: $\varnothing 330$ mm
 Carton Size: 370 x 350 x 350 mm
 Reel QTY: 2,500 pcs per reel
 Carton QTY: 25,000 pcs per carton

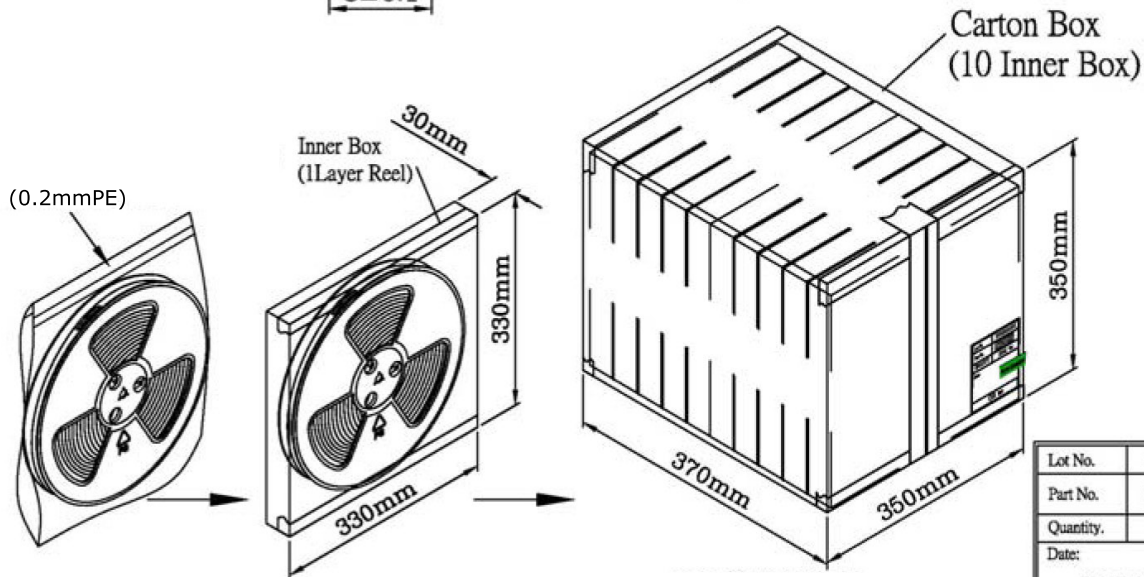
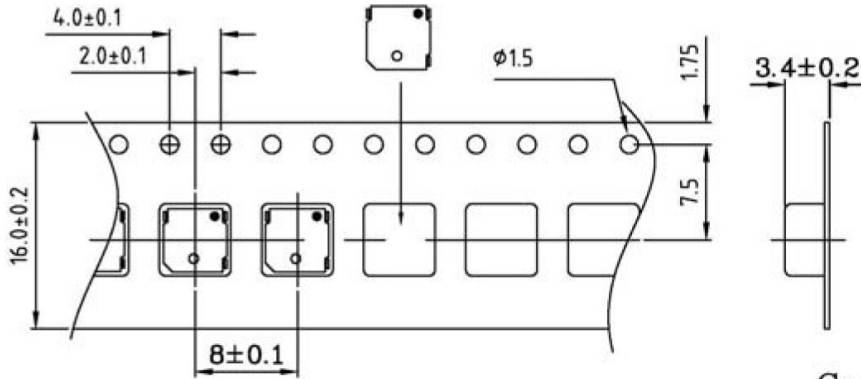
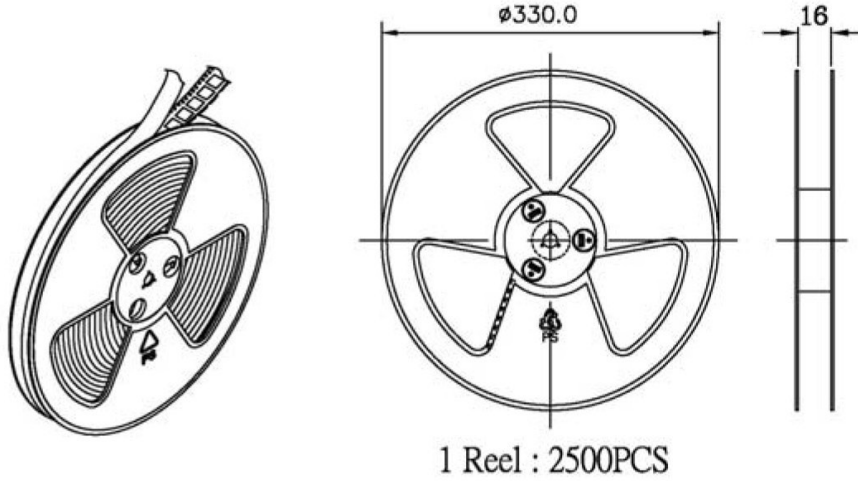

| | |
|-----------------------|------------|
| Lot No. | XXXXXXXXXX |
| Part No. | XXXXXXXXXX |
| Quantity. | XXXX Pcs |
| Date: | DD MM YY |
| RoHS Compliant | |
| CUI Inc | |

REVISION HISTORY

| rev. | description | date |
|------|-----------------|------------|
| 1.0 | initial release | 03/28/2016 |

The revision history provided is for informational purposes only and is believed to be accurate.



CUI INC[®]

Headquarters
20050 SW 112th Ave.
Tualatin, OR 97062
800.275.4899

Fax 503.612.2383
cui.com
techsupport@cui.com

CUI offers a one (1) year limited warranty. Complete warranty information is listed on our website.

CUI reserves the right to make changes to the product at any time without notice. Information provided by CUI is believed to be accurate and reliable. However, no responsibility is assumed by CUI for its use, nor for any infringements of patents or other rights of third parties which may result from its use.

CUI products are not authorized or warranted for use as critical components in equipment that requires an extremely high level of reliability. A critical component is any component of a life support device or system whose failure to perform can be reasonably expected to cause the failure of the life support device or system, or to affect its safety or effectiveness.