

PART NUMBER: CS-3612

DESCRIPTION: solid state buzzer

SPECIFICATONS

operating voltage	8 ~ 16 V DC	
current consumption	30 mA max.	at 12 V DC
sound pressure level	79 db min.	at 30 cm/12 V DC
tone	continuous	
operating temperature	-20 ~ +60° C	
storage temperature	-30 ~ +70° C	
weight	9.7 g max.	
RoHS	yes	

APPEARANCE DRAWING

tolerance: ±0.5
units: mm

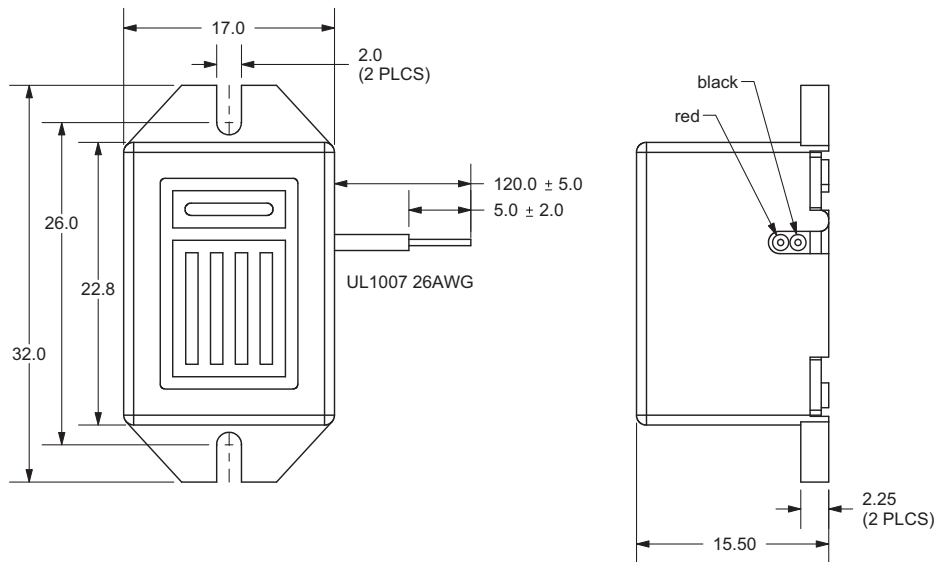

CURRENT CONSUMPTION/SOUND PRESSURE LEVEL

