

SERIES: PRQ3W-S | **DESCRIPTION:** DC-DC CONVERTER

FEATURES

- ultra-wide 4:1 input range
- dual positive output with asymmetrical options
- 3000 Vdc isolation
- input under-voltage protection
- output short circuit and over current protection
- wide operating temp: -40°C to +85°C
- EN62368 approved

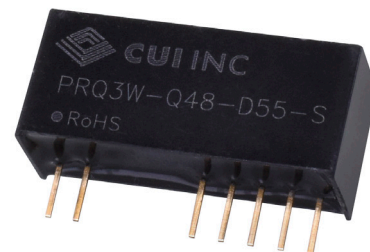

MODEL	input voltage range (Vdc)	output voltage Vo1/Vo2 (Vdc)	output current max Vo1/Vo2 (A)	output power max (W)	ripple and noise ¹ max Vo1/Vo2 (mVp-p)	efficiency ²	
						min (%)	typ (%)
PRQ3W-Q48-D55-S	18~75	5/5	300/300	3	150/150	76	78
PRQ3W-Q48-D512-S	18~75	5/12	300/125	3	150/150	76	78
PRQ3W-Q48-D524-S	18~75	5/24	300/63	3	150/150	76	78

Notes: 1. 20MHz bandwidth, nominal input, full load
2. Efficiency is measured In nominal input voltage and rated output load.

PART NUMBER KEY

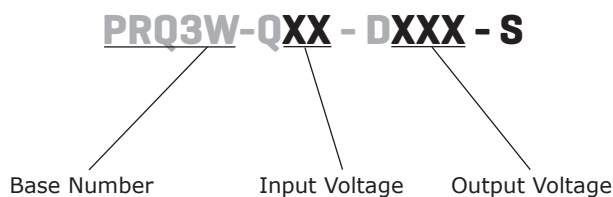

INPUT

parameter	conditions/description	min	typ	max	units
input voltage		18	48	80	Vdc
filter	capacitance filter				
current	full load/no load			83/12	mA

OUTPUT

parameter	conditions/description	min	typ	max	units
output capacitance	5V outputs			680	μ F
	12V outputs			330	μ F
	24V outputs			220	μ F
line regulation	low line to high line				
	Vo1 Vo2		± 0.2 ± 0.5	± 0.5 ± 1.0	%
load regulation	10~100% load				
	Vo1 Vo2		± 0.5 ± 1.1	± 1.0 ± 2.0	%
set-point accuracy	Vo1 / Vo2				
	10~100% load		$\pm 1/ \pm 3$	$\pm 3/ \pm 5$	%
	5~10% load		$\pm 2/ \pm 4$	$\pm 4/ \pm 6$	%
start-up time	nominal input and constant resistance load		10		ms
switching frequency			300		kHz
transient response				± 8 500	% Vout μ s
temperature coefficient	full load			± 0.03	%/ $^{\circ}$ C

PROTECTIONS

parameter	conditions/description	min	typ	max	units
over current protection		110		250	%Io
short circuit protection	output shutdown, auto recovery				

SAFETY AND COMPLIANCE

parameter	conditions/description	min	typ	max	units
isolation voltage	input to output	3000			Vdc
	output to output	1500			Vdc
isolation resistance	input-output resistance at 500 Vdc	1000			MΩ
isolation capacitance	input-output capacitance at 100 KHz/0.1 V		1000		pF
safety approvals	EN/IEC 62368				
EMI/EMC	EN 55032: 2015 Class B (see recommended circuit)				
ESD	IEC/EN61000-4-2, Contact ±4KV, perf. Criteria B				
radiated immunity	IEC/EN61000-4-3, 10 v/m, perf. Criteria A				
EFT/burst	IEC/EN61000-4-4, ±2KV (see recommended circuit), perf. Criteria B				
surge	IEC/EN61000-4-5, line to line ±2KV (see recommended circuit), perf. Criteria B				
conducted immunity	IEC/EN61000-4-6, 3 Vr.m.s, perf. Criteria A				
RoHS	yes				
MTBF	MIL-HDBK-217@25°C	1000			kHours

ENVIRONMENTAL

parameter	conditions/description	min	typ	max	units
operating temperature		-40		85	°C
storage temperature		-55		125	°C
humidity	non-condensing	5		95	%
shock/vibration	10-150Hz, 5G, 0.75mm. along X, Y and Z				

MECHANICAL

parameter	conditions/description	min	typ	max	units
dimensions	27.40 x 9.50 x 12.00				mm
case material	Black flame-retardant and heat-resistant plastic (UL94 V-0)				
weight			5.4		g

MECHANICAL DRAWING

units: mm [inches]
 tolerance: ± 0.50 [±0.020]

PIN CONNECTIONS	
PIN	FUNCTION
1	GND
2	Vin
6	+Vo1
7	-Vo1
8	CS*
9	-Vo2
10	+Vo2

* Connecting a low ESR capacitor between CS & pin 7 may reduce output ripple & noise. Maximum value = 47 µF

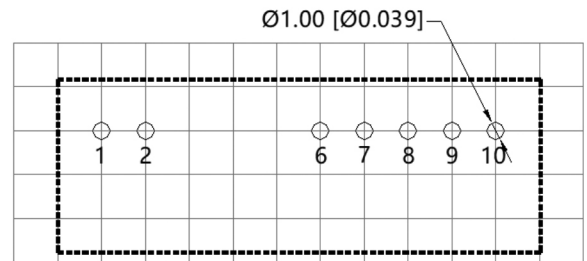
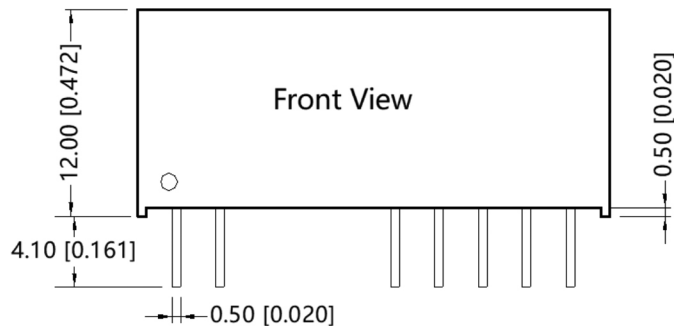

Note : Grid 2.54*2.54mm

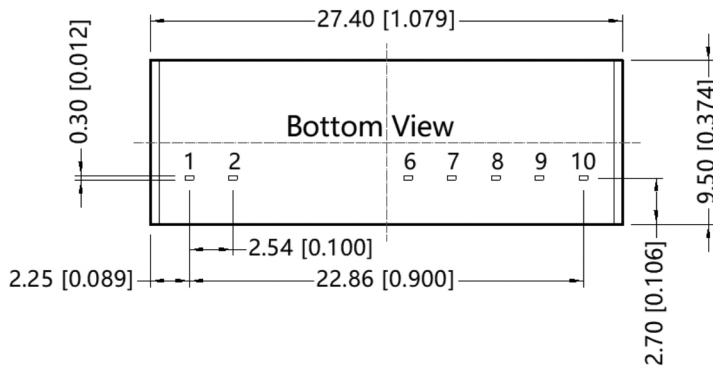

DERATING CURVES

Figure 1

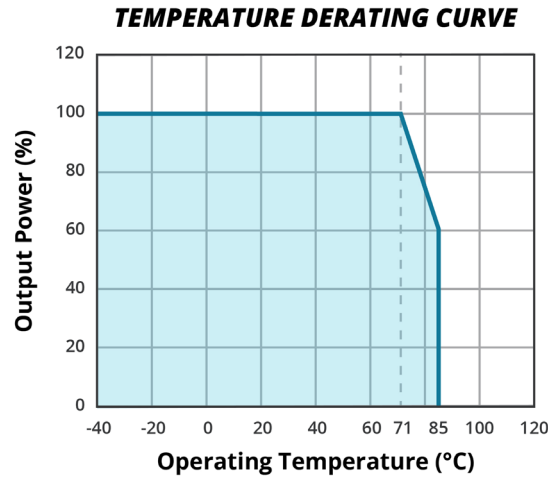

APPLICATION CIRCUIT

All the dc-dc converters of this series are tested before delivery using the recommended circuit shown in Fig. 2.

Input and/or output ripple can be further reduced by appropriately increasing the input & output capacitor values C_{in} and C_{out} and/or by selecting capacitors with a low ESR (equivalent series resistance). Also make sure that the capacitance is not exceeding the max. capacitive load value of the product.

Figure 2

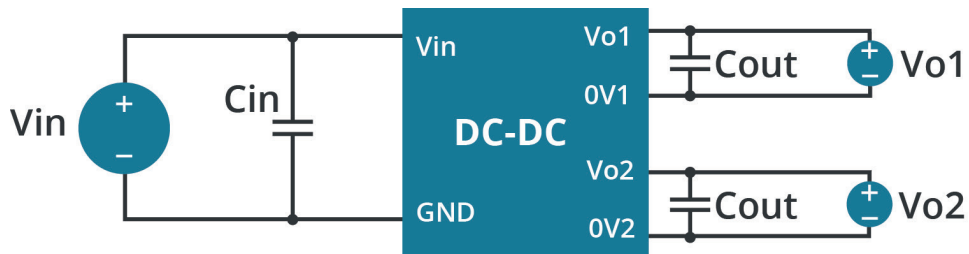

Table 1

output voltage (Vdc)	C_{in} (uF)	C_{out} (uF)
5	47	100
12	22	
24	22	

EMC RECOMMENDED CIRCUITS

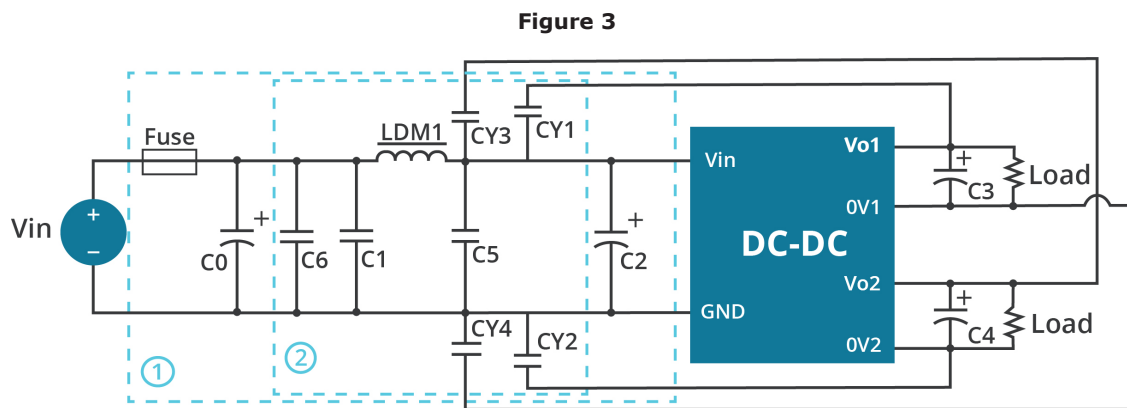

Table 2

List of Components	
Model	Vin:48V
FUSE	Choose according to actual input current
C0	680 μ F/100V
C1/C5/C6	4.7 μ F/100V
C2	330 μ F/100V
C3/C4	Refer to the Cout in Fig.2
LDM1	22 μ H/0.6A
CY1/CY2/CY4	1nF/3kV
CY3	2.2nF/3kV

REVISION HISTORY

rev.	description	date
1.0	initial release	05/26/2020
1.01	derating curve and circuit figures updated	07/15/2021

The revision history provided is for informational purposes only and is believed to be accurate.



Headquarters
20050 SW 112th Ave.
Tualatin, OR 97062
800.275.4899

Fax 503.612.2383
cui.com
techsupport@cui.com

CUI offers a two (2) year limited warranty. Complete warranty information is listed on our website.

CUI reserves the right to make changes to the product at any time without notice. Information provided by CUI is believed to be accurate and reliable. However, no responsibility is assumed by CUI for its use, nor for any infringements of patents or other rights of third parties which may result from its use.

CUI products are not authorized or warranted for use as critical components in equipment that requires an extremely high level of reliability. A critical component is any component of a life support device or system whose failure to perform can be reasonably expected to cause the failure of the life support device or system, or to affect its safety or effectiveness.