

**SERIES:** PRC10W | **DESCRIPTION:** DC-DC CONVERTER

**FEATURES**

- 10W isolated output
- ultra-wide 18:1 input range (8.5~160 Vdc)
- single/dual regulated outputs
- 4,200 Vdc isolation
- over voltage, over current, short circuit, UVLO protection
- certified to IEC/BS EN/UL 62368-1
- meets EN 50155 with external circuit
- reinforced insulation

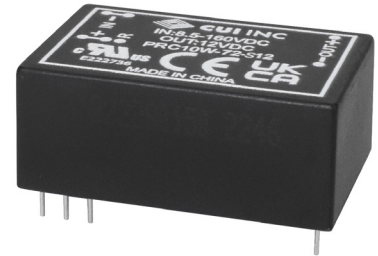

MODEL	input voltage		output voltage	output current		output power	ripple & noise <sup>1</sup>	efficiency <sup>2</sup>
	typ (Vdc)	range (Vdc)	(Vdc)	min (mA)	max (mA)	max (W)	max (mVp-p)	typ (%)
PRC10W-72-S5	72	8.5 ~ 160	5	0	2,000	10	100	84
PRC10W-72-S12	72	8.5 ~ 160	12	0	835	10	100	88
PRC10W-72-S15	72	8.5 ~ 160	15	0	668	10	100	88
PRC10W-72-D5	72	8.5 ~ 160	±5	0	±1,000	10	100	83
PRC10W-72-D12	72	8.5 ~ 160	±12	0	±416	10	100	87
PRC10W-72-D15	72	8.5 ~ 160	±15	0	±333	10	100	87

Notes: 1. Measured at 5Hz to 20MHz bandwidth, peak to peak.  
2. At nominal input voltage 72Vdc.

**PART NUMBER KEY**

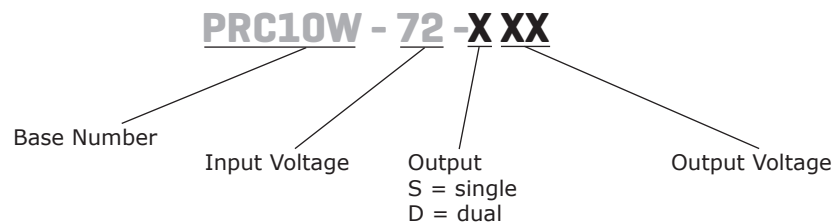

**INPUT**

parameter	conditions/description	min	typ	max	units
operating input voltage		8.5	72	160	Vdc
surge voltage	for maximum of 100 ms			200	Vdc
input undervoltage lockout	turn-on voltage treshold at 80% load	8.2	9	9.5	Vdc
	turn-off voltage treshold at 80% load	6.9	7.5	8.0	Vdc
	lockout hysteresis voltage at 80% load		1.5		Vdc
current	Vin = 12V, full load Vin = 8.5V, 80% load			1.3	A
input filter	LC filter				
inrush current (I <sup>2</sup> t)	as per ETS300 132-2			0.1	A <sup>2</sup> s
input reflected ripple current	P-P thru 12uH inductor, 5Hz to 20MHz		30		mA
CTRL	module on: CTRL pin open or pulled high (3.5~160 Vdc) module off: CTRL pin pulled low to GND (0~1.2 Vdc) CTRL pin current when pulled low		0.4	1	mA

**OUTPUT**

parameter	conditions/description	min	typ	max	units
maximum capacitive load	5 Vdc output			2,000	μF
	12 Vdc output			835	μF
	15 Vdc output			668	μF
	±5 Vdc output			1,000	μF
	±12 Vdc output			416	μF
	±15 Vdc output			333	μF
voltage accuracy	Vin = 72V, full load, 25°C			±1	%
output voltage balance	Vin = 72V, full load, 25°C, dual models only			±1	%
line regulation	input voltage from low to high, full load			±0.2	%
load regulation	0%~100% load single output models			±0.5	%
	dual output models			±1	%
cross regulation	load cross variation 25%/100%, dual output models			±5	%
switching frequency		230	255	280	kHz
transient recovery time	75% to 100% load step change, 0.1 A/us, within 1% nominal input voltage			250	μs
transient response deviation	75% to 100% load step change, 0.1 A/us			±5	%
temperature coefficient	40°C to 100°C			±0.02	%/°C

## PROTECTIONS

parameter	conditions/description	min	typ	max	units
over voltage protection	zener clamp, single output only				
	5 Vdc output		6.2		Vdc
	12 Vdc output		15		Vdc
	15 Vdc output		18		Vdc
over current protection	auto recovery, hiccup	110	150	180	%
short circuit protection	continuous, auto recovery				

## SAFETY AND COMPLIANCE

parameter	conditions/description	min	typ	max	units
isolation voltage	input to output, for 1 minute			3,000 4,200	Vac Vdc
isolation resistance	input to output	1,000			MΩ
isolation capacitance	input to output, 100kHz / 0.25V		16		pF
safety approvals	certified to 62368: IEC, BS EN, UL designed to meet 50155: EN designed to meet 45545-2: EN				
conducted emissions	EN55032 and EN50155 Compliant (with external filter)				
radiated emissions	EN55032 and EN50155 Compliant (with external filter)				
ESD	EN 61000-4-2 Level 3: Air ±8kV, Contact± 6kV, perf. Criteria A				
radiated immunity	EN 61000-4-3 Level 3: 80~1000MHz, 20 V/m, perf. Criteria A				
EFT/burst	EN61000-4-4 Level 3: On power input port, ±2kV, external input capacitor required, perf. Criteria A				
surge	EN 61000-4-5 Level 4: Line to earth, ±4kV, line to line, ±2kV, perf. Criteria A				
conducted immunity	EN 61000-4-6 Level 3: 0.15~80MHz, 10V, perf. Criteria A				
voltage dips and interruptions	EN 50155 Class S3: 20ms interruptions, perf. Criteria A				
MTBF	as per MIL-HDBK-217F, 25°C				
	5 Vdc output		1,654		K hours
	12 Vdc output		2,295		K hours
	15 Vdc output		2,363		K hours
	±5 Vdc output		1,664		K hours
	±12 Vdc output		2,093		K hours
	±15 Vdc output		2,335		K hours
RoHS	yes				

## ENVIRONMENTAL

parameter	conditions/description	min	typ	max	units
operating temperature	see derating curve	-40		100	°C
storage temperature		-55		125	°C
storage humidity	non-condensing			95	%

## MECHANICAL

parameter	conditions/description	min	typ	max	units
dimensions	31.8 x 20.3 x 12.7 [1.25 x 0.80 x 0.50 inch]				mm
weight			16		g
case material	plastic, DAP, UL 94V-0				
base material	plastic, LCP, UL 94V-0				
potting material	UL 94V-0				
pin material	base: copper plated steel wire plating: tin				
cooling method	natural convection				

## MECHANICAL DRAWING

units: inch [mm]  
 pin size diameter: 0.02±0.002 inch (0.5±0.05mm)  
 general tolerance: inches: x.xx = ±0.02, x.xxx = ±0.010  
 mm: x.x = ±0.5, x.xx = ±0.25

Pin Out		
PIN	Single outputs	Dual outputs
1	+Vin	+Vin
2	+Vin	+Vin
3	Remote on/off	Remote on/off
11	NP	Common
12	-Vout	NP
13	+Vout	-Vout
15	NP	+Vout
23	-Vin	-Vin
24	-Vin	-Vin

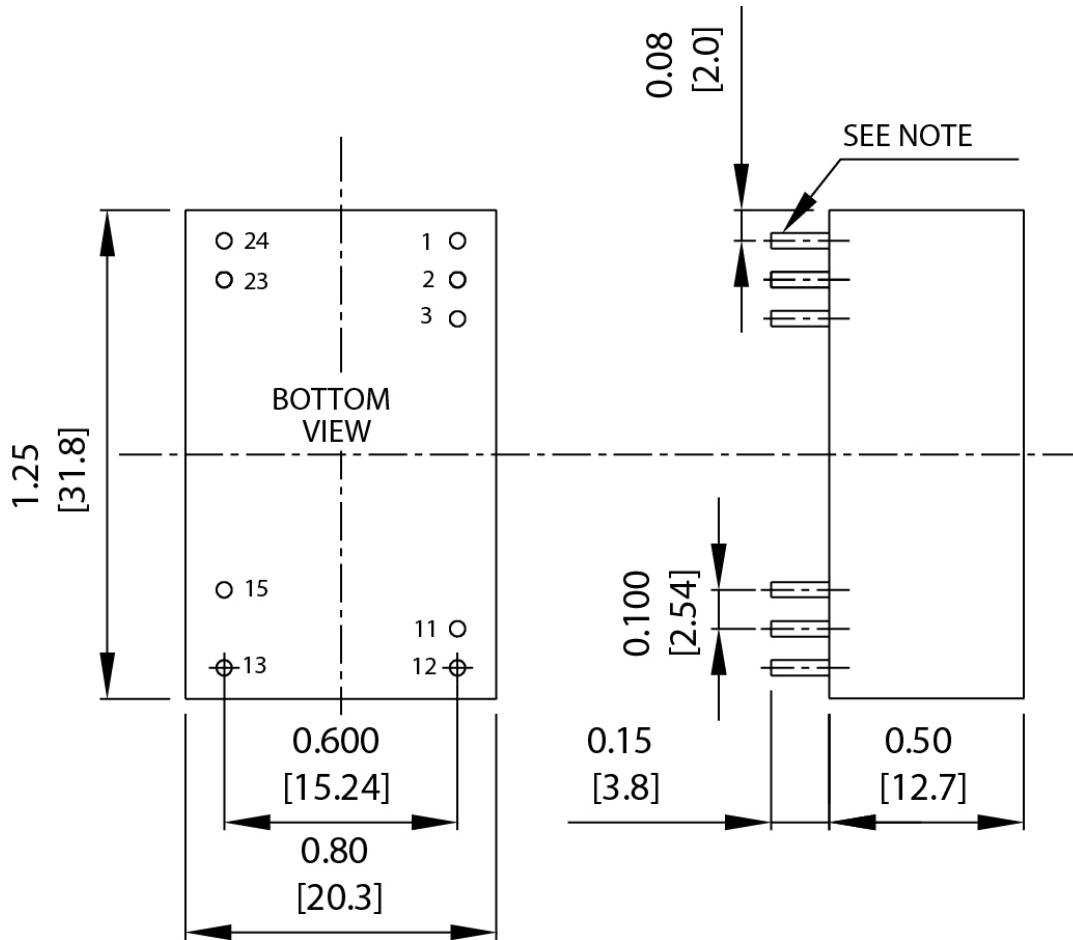

## DERATING CURVE

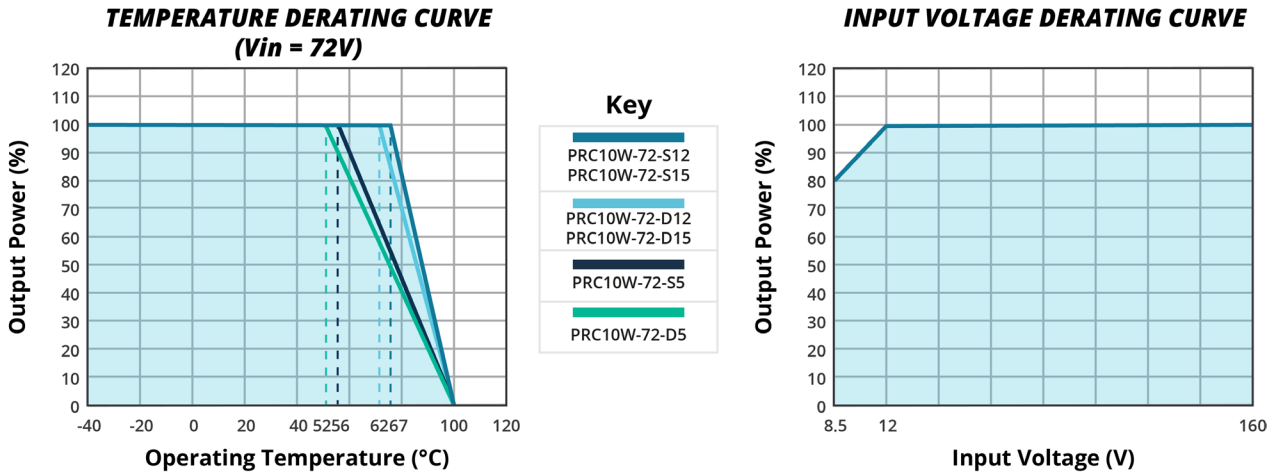

## EFFICIENCY CURVES

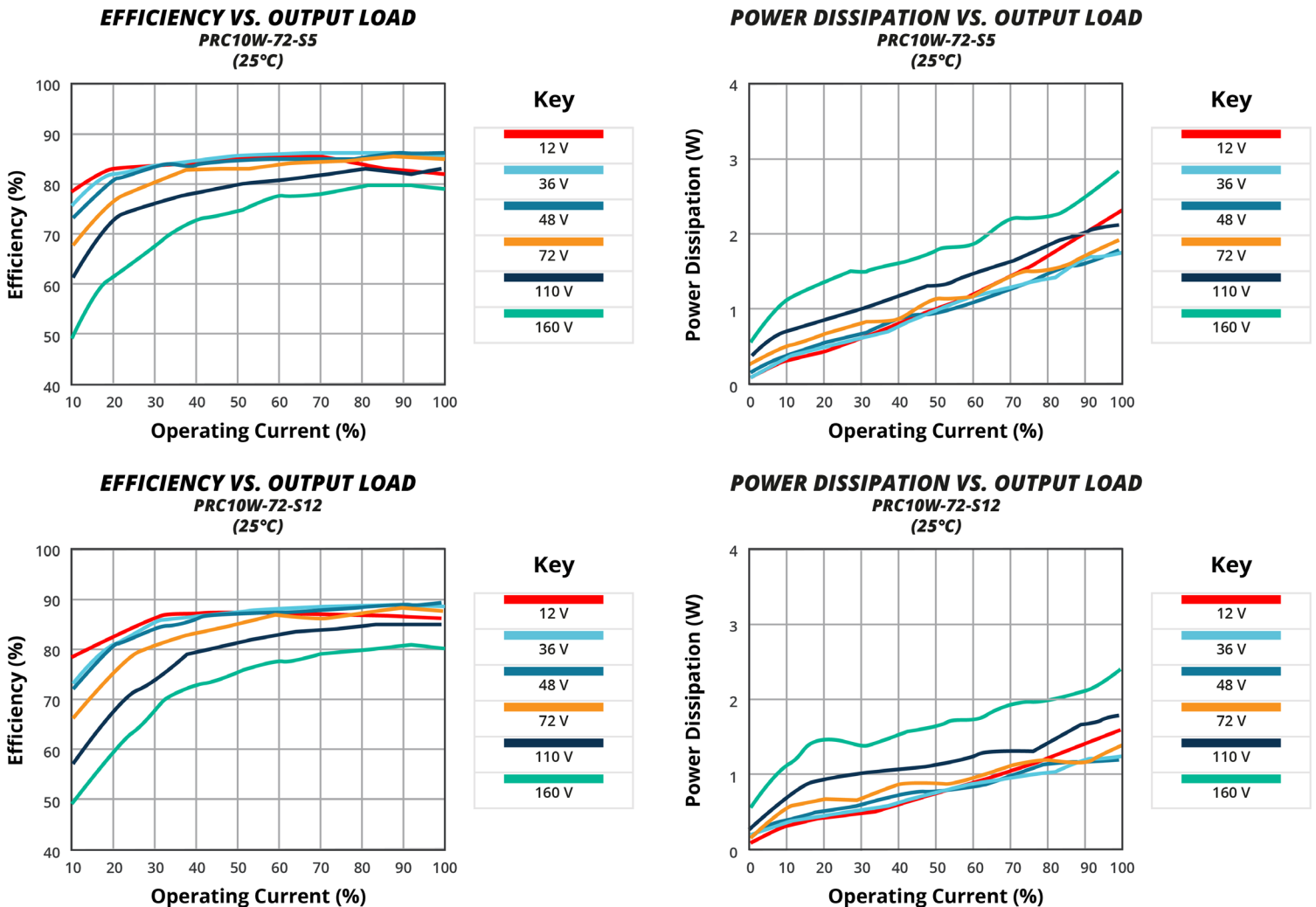

## EFFICIENCY CURVES (CONTINUED)

**EFFICIENCY VS. OUTPUT LOAD**  
**PRC10W-72-S15**  
 (25°C)

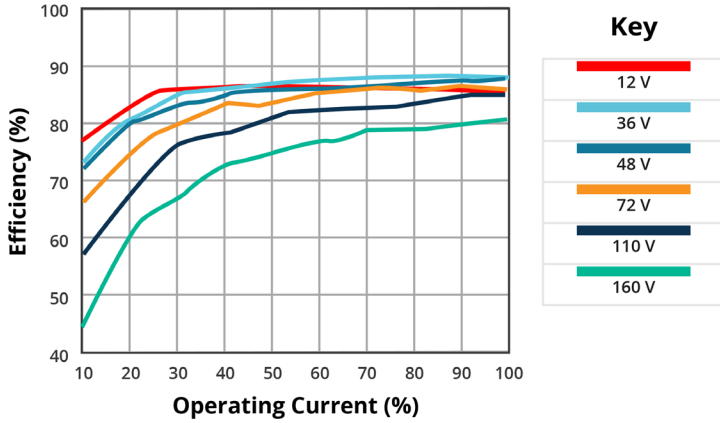

**POWER DISSIPATION VS. OUTPUT LOAD**  
**PRC10W-72-S15**  
 (25°C)

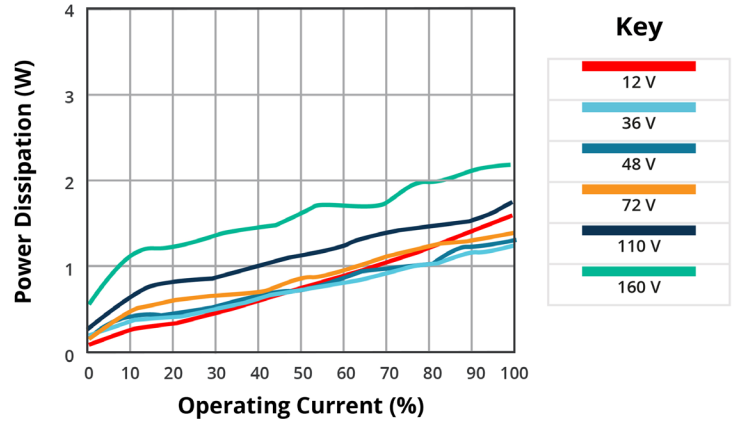

**EFFICIENCY VS. OUTPUT LOAD**  
**PRC10W-72-D5**  
 (25°C)

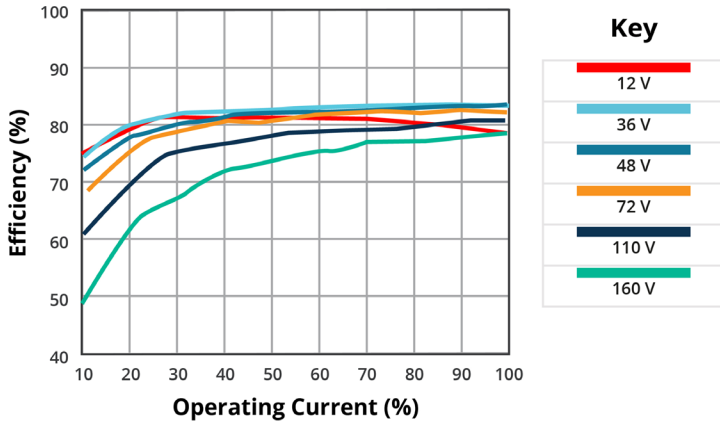

**POWER DISSIPATION VS. OUTPUT LOAD**  
**PRC10W-72-D5**  
 (25°C)

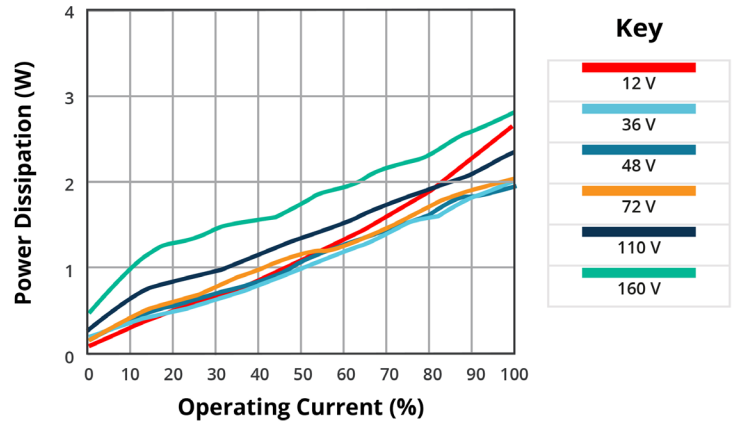

**EFFICIENCY VS. OUTPUT LOAD**  
**PRC10W-72-D12**  
 (25°C)

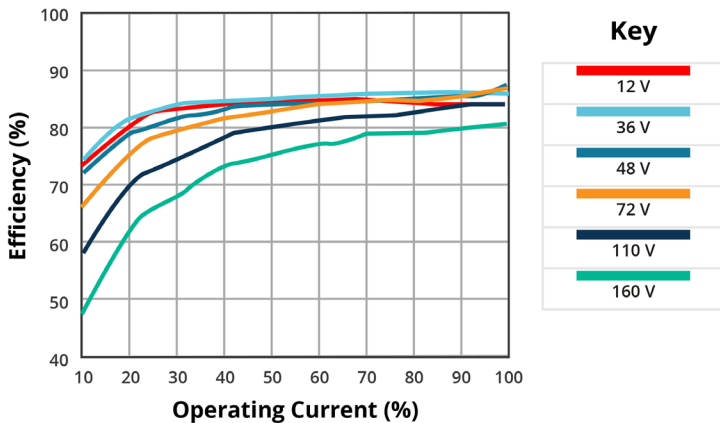

**POWER DISSIPATION VS. OUTPUT LOAD**  
**PRC10W-72-D12**  
 (25°C)

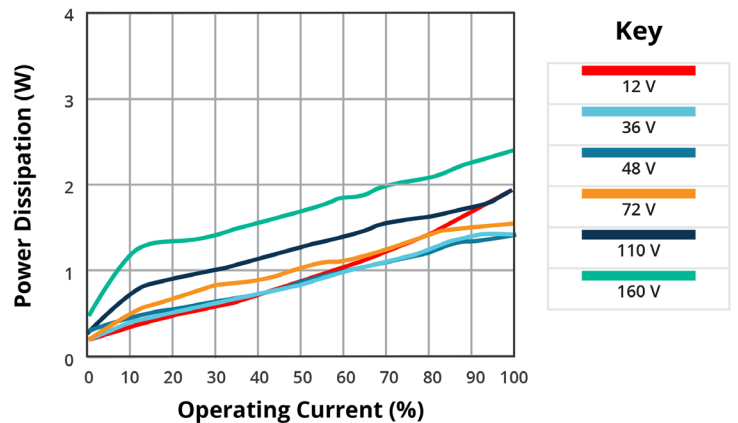

## EFFICIENCY CURVES (CONTINUED)

**EFFICIENCY VS. OUTPUT LOAD**  
**PRC10W-72-D15**  
 (25°C)

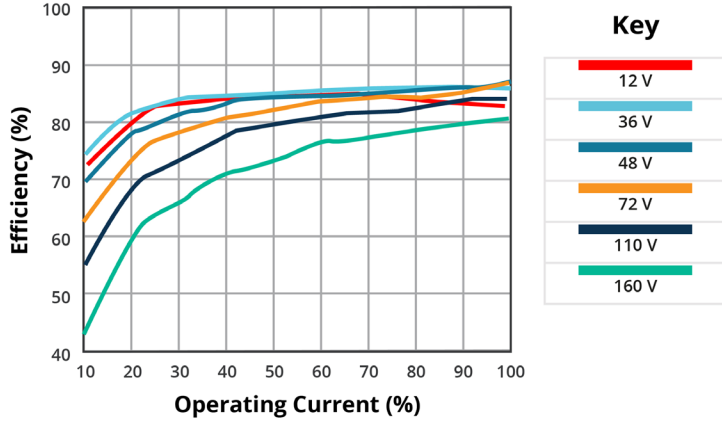

**POWER DISSIPATION VS. OUTPUT LOAD**  
**PRC10W-72-D15**  
 (25°C)

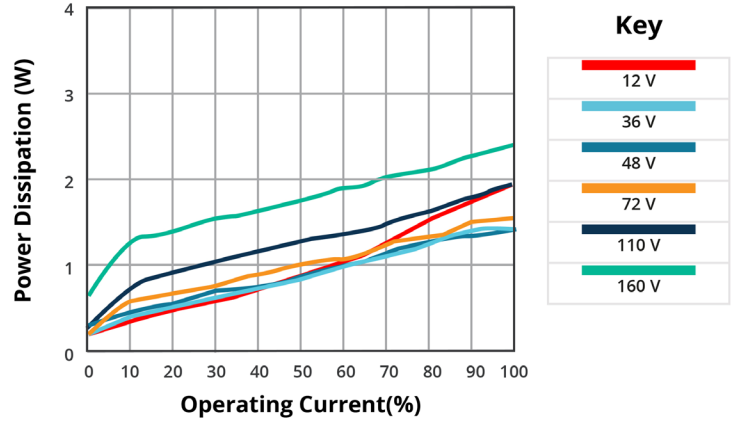

**EFFICIENCY VS. INPUT VOLTAGE**  
**PRC10W-72-S5**  
 (25°C)

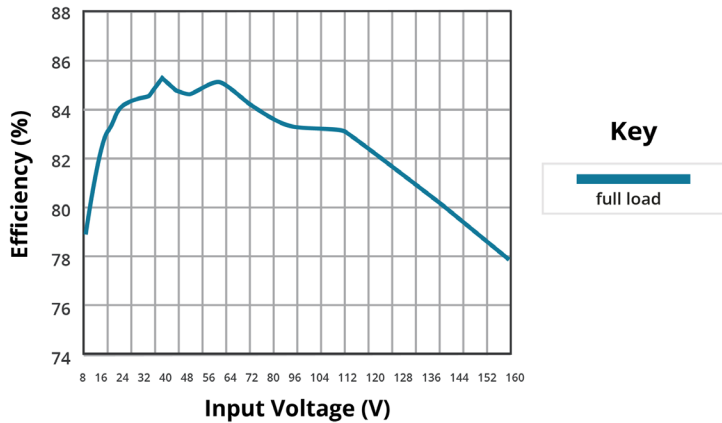

**EFFICIENCY VS. INPUT VOLTAGE**  
**PRC10W-72-S12**  
 (25°C)

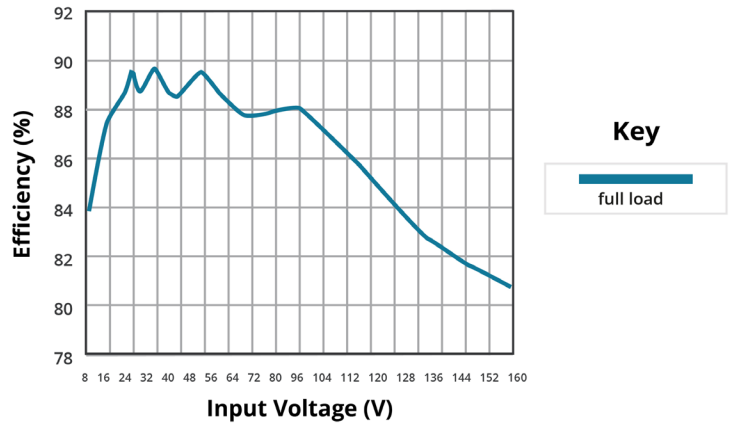

**EFFICIENCY VS. INPUT VOLTAGE**  
**PRC10W-72-S15**  
 (25°C)

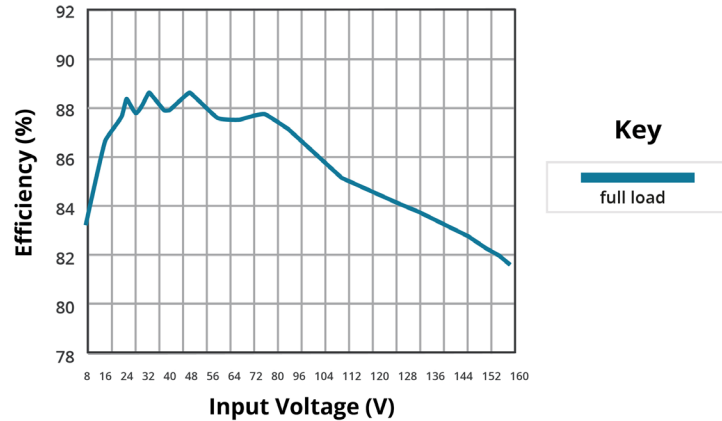

**EFFICIENCY VS. INPUT VOLTAGE**  
**PRC10W-72-D5**  
 (25°C)

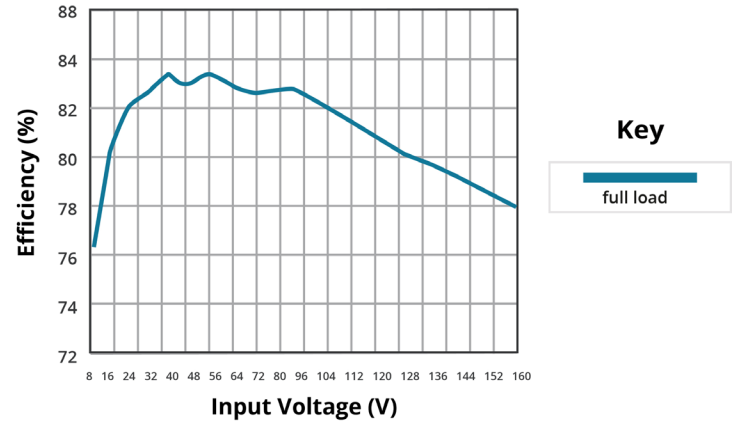

## EFFICIENCY CURVES (CONTINUED)

**EFFICIENCY VS. INPUT VOLTAGE**  
**PRC10W-72-D12**  
**(25°C)**

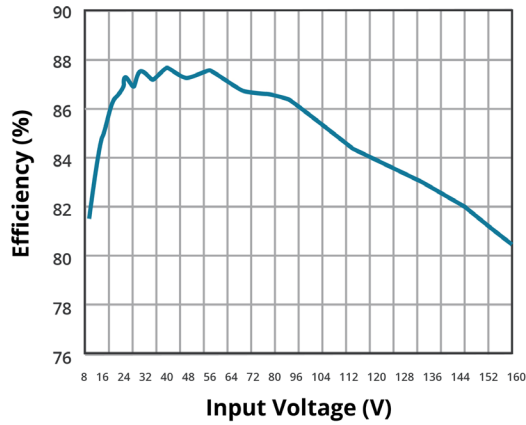

**Key**  
full load

**EFFICIENCY VS. INPUT VOLTAGE**  
**PRC10W-72-D15**  
**(25°C)**

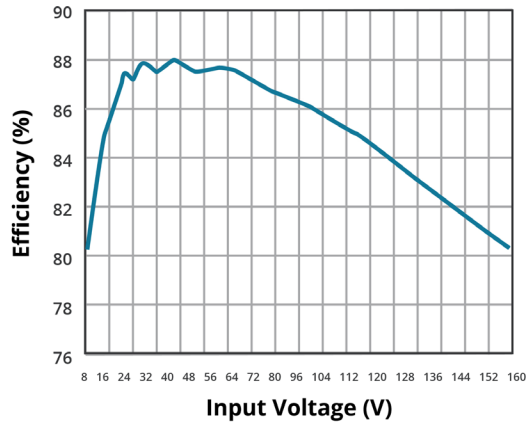

**Key**  
full load



## REVISION HISTORY

---

rev.	description	date
1.0	initial release	12/19/2022
1.01	safeties updated	01/16/2023

The revision history provided is for informational purposes only and is believed to be accurate.



**Headquarters**  
20050 SW 112th Ave.  
Tualatin, OR 97062  
**800.275.4899**

Fax 503.612.2383  
**cui.com**  
techsupport@cui.com

CUI offers a two (2) year limited warranty. Complete warranty information is listed on our website.

CUI reserves the right to make changes to the product at any time without notice. Information provided by CUI is believed to be accurate and reliable. However, no responsibility is assumed by CUI for its use, nor for any infringements of patents or other rights of third parties which may result from its use.

CUI products are not authorized or warranted for use as critical components in equipment that requires an extremely high level of reliability. A critical component is any component of a life support device or system whose failure to perform can be reasonably expected to cause the failure of the life support device or system, or to affect its safety or effectiveness.