

**SERIES:** PSK-20F | **DESCRIPTION:** INTERNAL AC-DC POWER SUPPLY
**FEATURES**

- up to 20 W continuous output power
- universal input (85~305 Vac, 100~430 Vdc)
- -40~85°C operating range
- output short circuit/over voltage/current protection
- 4,200 Vac input/output isolation voltage
- OVC III (meets EN 62477-1)
- CISPR32/EN55032 Class B
- UL/EN/IEC 62368-1 certified
- designed to meet IEC/EN 60335



MODEL	output voltage	output current	output power	ripple and noise <sup>1</sup>	efficiency <sup>2</sup>
	(Vdc)	max (A)	max (W)	max (mVp-p)	typ (%)
PSK-20F-3	3.3	4.00	13.2	150	83
PSK-20F-5	5	4.00	20.0	150	86
PSK-20F-9	9	2.22	20.0	150	86
PSK-20F-12	12	1.67	20.0	150	87
PSK-20F-15	15	1.33	20.0	150	88
PSK-20F-24	24	0.83	20.0	150	87
PSK-20F-48	48	0.41	20.0	250	89

Notes: 1. At full load, nominal input, 20 MHz bandwidth oscilloscope, with 1  $\mu$ F ceramic and 10  $\mu$ F electrolytic capacitors on the output.  
 2. At 230 Vac input.  
 3. All specifications are measured at Ta=25°C, humidity <75%, nominal input voltage, and rated output load unless otherwise specified.

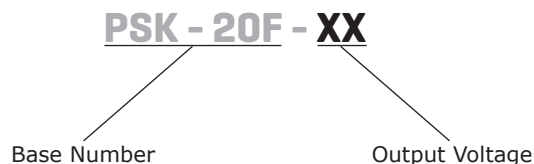
**PART NUMBER KEY**

**INPUT**

parameter	conditions/description	min	typ	max	units
voltage	ac input	85		305	Vac
	dc input	100		430	Vdc
frequency		47		63	Hz
current	at 115 Vac			0.5	A
	at 230 Vac			0.3	A
inrush current	at 115 Vac		20		A
	at 230 Vac		40		A
leakage current	at 277 Vac/50 Hz			0.1	mA
recommended external input fuse	3.15A/300V, slow-blow, required				

**OUTPUT**

parameter	conditions/description	min	typ	max	units
capacitive load	3.3 & 5 Vdc output model			8,000	μF
	9 Vdc output model			5,400	μF
	12 Vdc output model			4,000	μF
	15 Vdc output model			3,000	μF
	24 Vdc output model			1,000	μF
	48 Vdc output model			330	μF
output voltage accuracy			±2		%
line regulation	at full load		±0.5		%
load regulation	0~100% load		±1.0		%
hold-up time	at 115 Vac		5		ms
	at 230 Vac		40		ms
switching frequency			70		kHz
temperature coefficient			±0.02		%/°C
no load power consumption	at 230 Vac				
	3.3 Vdc, 5 Vdc, 9 Vdc, 12 Vdc, 15 Vdc & 24 Vdc outputs 48 Vdc output		0.12 0.2		W W

**PROTECTIONS**

parameter	conditions/description	min	typ	max	units
over voltage protection	clamp or hiccup				
	3.3 & 5 Vdc output			7.5	Vdc
	9 & 12 Vdc output			16	Vdc
	15 Vdc output			20	Vdc
	24 Vdc output			30	Vdc
48 Vdc output			60	Vdc	
over current protection	auto recovery		120		%
short circuit protection	continuous, auto recovery, hiccup				

## SAFETY & COMPLIANCE

parameter	conditions/description	min	typ	max	units
isolation voltage	input to output for 1 minute, 5mA max	4,200			Vac
safety approvals	certified to 62368-1: UL, EN, IEC designed to meet 60335: EN, IEC				
safety class	Class II				
conducted emissions	CISPR32/EN55032 CLASS B				
radiated emissions	CISPR32/EN55032 CLASS B				
ESD	IEC/EN61000-4-2 Contact $\pm 6\text{KV}$ /Air $\pm 8\text{KV}$ , perf. Criteria A				
radiated immunity	IEC/EN61000-4-3 10V/m, perf. Criteria A				
EFT/burst	IEC/EN61000-4-4 $\pm 2\text{KV}$ , perf. Criteria A IEC/EN61000-4-4 $\pm 4\text{KV}$ , perf. Criteria A (see Fig. 2 & Fig. 3 for recommended circuit)				
surge	IEC/EN61000-4-5 line to line $\pm 1\text{KV}$ , perf. Criteria A IEC/EN61000-4-5 line to line $\pm 2\text{KV}$ /line to PE $\pm 4\text{KV}$ , perf. Criteria A (see Fig. 2 & Fig. 3 for recommended circuit)				
conducted immunity	IEC/EN61000-4-6 10Vrms, perf. Criteria A				
PFMF	IEC/EN61000-4-8 10A/m, perf. Criteria A				
voltage dips and interruption	IEC/EN61000-4-11 0%, 70%, perf. Criteria B				
MTBF	MIL-HDBK-217F at 25°C	1,000,000			hours
RoHS	yes				

## ENVIRONMENTAL

parameter	conditions/description	min	typ	max	units
operating temperature	see derating curve	-40		85	°C
storage temperature		-40		85	°C
storage humidity		0		95	%

## SOLDERABILITY

parameter	conditions/description	min	typ	max	units
wave soldering	5~10 seconds max	255	260	265	°C
hand soldering	3~5 seconds max	350	360	370	°C

## MECHANICAL

parameter	conditions/description	min	typ	max	units
dimensions	52.40 x 27.20 x 24.00 [2.063 x 1.070 x 0.945 inches]				mm
weight			55		g
case material	black plastic, flame-retardant and heat-resistant (UL94V-0)				
cooling method					

## MECHANICAL DRAWING

units: mm [inch]  
 pin 1,2,4,5:  $\varnothing 1.05$  [0.041]  
 pin diameter tolerance:  $\pm 0.1$  [ $\pm 0.004$ ]  
 tolerance:  $\pm 0.50$  [ $\pm 0.020$ ]

PIN CONNECTIONS	
PIN	Function
1	AC(N)
2	AC(L)
3	no pin
4	-Vo
5	+Vo

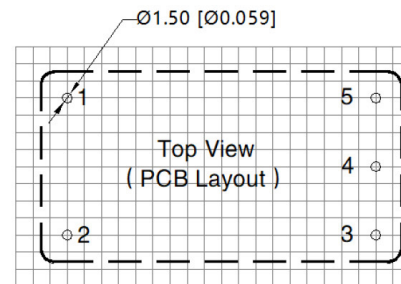
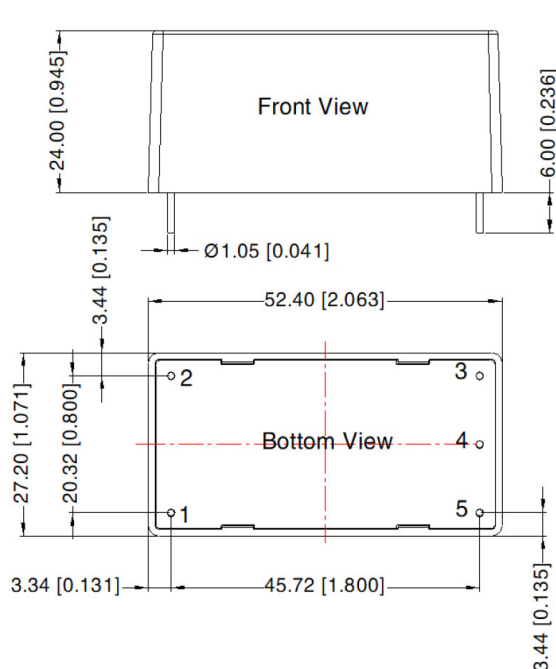

Note: Grid 2.54\*2.54mm

## APPLICATION DESIGN REFERENCE

### Output Filtering Components:

C1 is a ceramic capacitor used for filtering high-frequency noise and TVS is a recommended suppressor diode to protect the application in case of a converter failure.

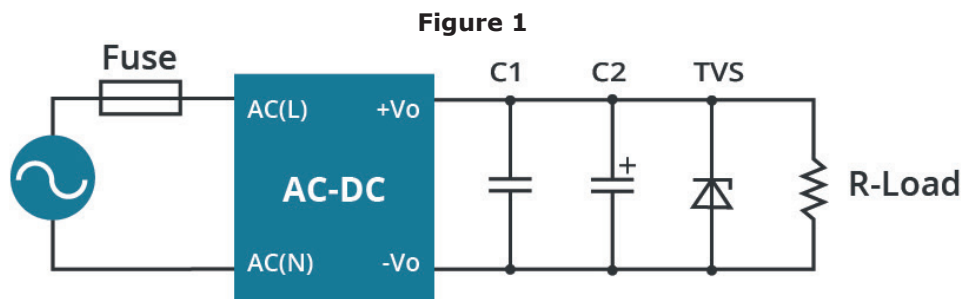
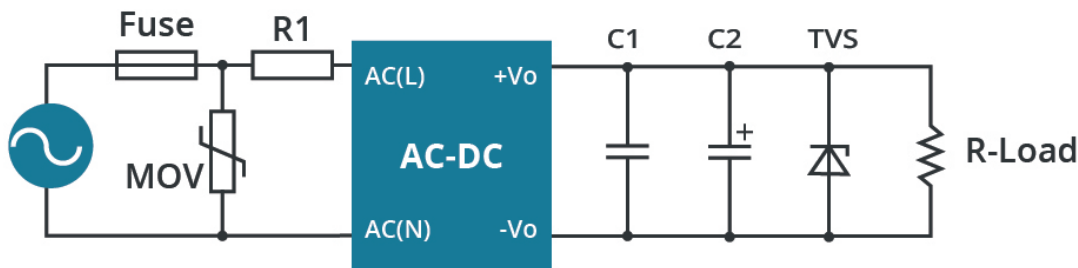

**Table 1**

Part No.	Fuse	C1	C2	TVS
PSK-20F-3	3.15A/300V, slow blow, required	1 $\mu$ F/50V	820 $\mu$ F/16V	SMBJ7.0A
PSK-20F-5			820 $\mu$ F/16V	SMBJ7.0A
PSK-20F-9			10 $\mu$ F/25V	SMBJ12A
PSK-20F-12			10 $\mu$ F/25V	SMBJ16A
PSK-20F-15			10 $\mu$ F/25V	SMBJ20A
PSK-20F-24			10 $\mu$ F/35V	SMBJ30A
PSK-20F-48		1 $\mu$ F/100V	10 $\mu$ F/65V	SMBJ60A

## EMC RECOMMENDED CIRCUIT

Figure 2



Note: EMC application circuit with higher requirements.

Table 2

Components	Recommended Value
FUSE	3.15A/300V, slow-blow, required
MOV	S14K350
R1	12Ω/5W (wire-wound resistor, required)

Figure 3

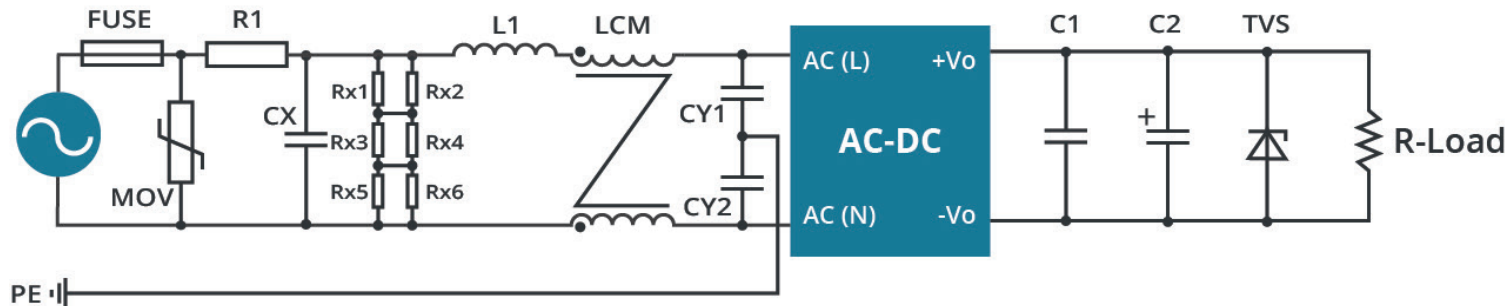

Note: EMC application circuit with higher requirements(Class I).

Table 3

Components	Recommended Value
FUSE	3.15A/300V, slow-blow, required
MOV	S14K350
R1	12Ω/5W (wire-wound resistor, required)
CX	0.1μF/310Vac
L1	4.7μH/2A
LCM	10mH/0.6A
CY1, CY2	1000pF/400Vac

Note: Rx1/Rx2/Rx3/Rx4/Rx5/Rx6 is the bleeder resistance of CX, and the recommended resistance value is 15MΩ/150Vdc.

## DERATING CURVE

**TEMPERATURE DERATING CURVE**  
(Input voltage: 85~305 Vac, 100~430 Vdc)

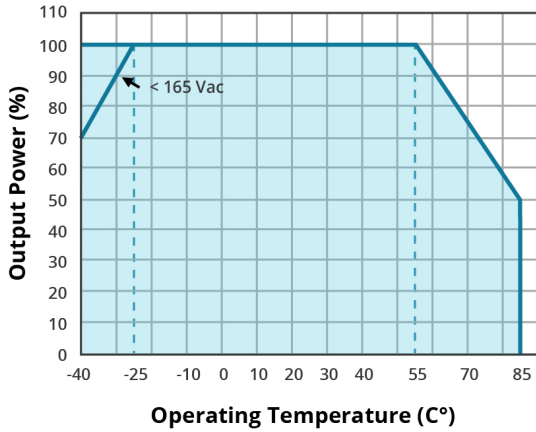

**INPUT VOLTAGE DERATING CURVE**  
(25 °C)

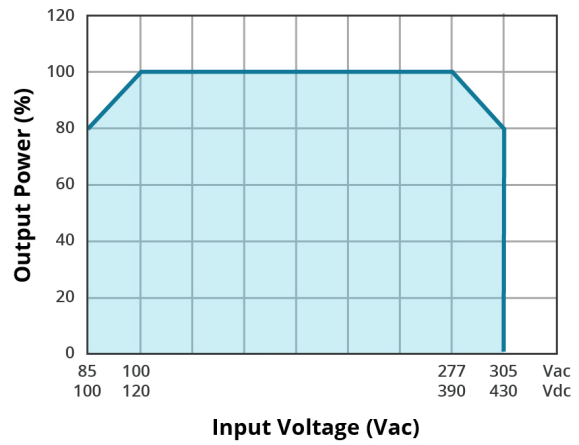

Note: 1. With an AC input between 85~100V/277~305Vac and a DC input between 100~120V/390~430Vdc, the output power must be derated as per temperature derating curves.  
2. This product is suitable for applications using natural air cooling; for applications in closed environment please consult with CUI.

## EFFICIENCY CURVES

**EFFICIENCY VS INPUT VOLTAGE**  
(full load)

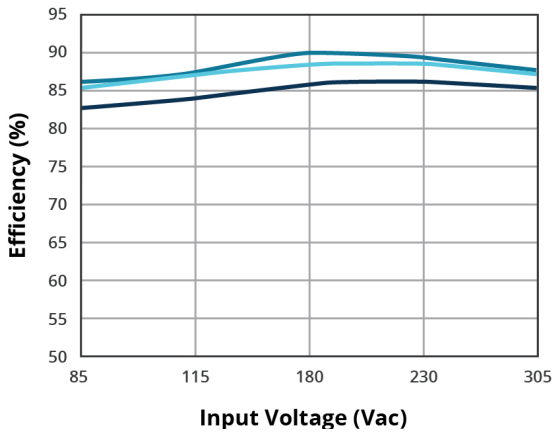

**EFFICIENCY VS OUTPUT LOAD**  
(Vin = 230 Vac)

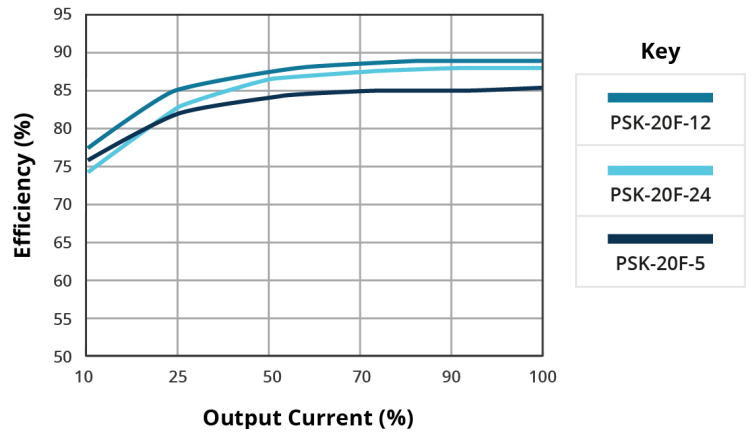

## REVISION HISTORY

---

rev.	description	date
1.0	initial release	11/14/2023
1.01	mechanical drawing updated	12/15/2023

The revision history provided is for informational purposes only and is believed to be accurate.



**Headquarters**  
20050 SW 112th Ave.  
Tualatin, OR 97062  
**800.275.4899**

Fax 503.612.2383  
**cui.com**  
techsupport@cui.com

CUI offers a two (2) year limited warranty. Complete warranty information is listed on our website.

CUI reserves the right to make changes to the product at any time without notice. Information provided by CUI is believed to be accurate and reliable. However, no responsibility is assumed by CUI for its use, nor for any infringements of patents or other rights of third parties which may result from its use.

CUI products are not authorized or warranted for use as critical components in equipment that requires an extremely high level of reliability. A critical component is any component of a life support device or system whose failure to perform can be reasonably expected to cause the failure of the life support device or system, or to affect its safety or effectiveness.