

SERIES: PSK-40D | **DESCRIPTION:** INTERNAL AC-DC POWER SUPPLY
FEATURES

- universal 85-305Vac or 100-430Vdc input voltage
- operating ambient temperature range: -40°C ~ 85°C
- high I/O isolation test voltage up to 4200Vac
- up to 90% efficiency
- compact size, high power density
- output short circuit, over-current, over-voltage protection
- OVC III (meet EN 62477, 5000m altitude)
- 5000m altitude application
- meets Emissions CLASS B and surge ± 2 KV without external circuits



MODEL	output voltage	output current	output power	ripple and noise ¹	efficiency ²
	(Vdc)	max (A)	max (W)	max (mVp-p)	typ (%)
PSK-40D-5	5	7.0	35	150	86
PSK-40D-12	12	3.33	40	150	89
PSK-40D-15	15	2.67	40	150	90
PSK-40D-24	24	1.67	40	150	89
PSK-40D-48	48	0.83	40	150	90

Notes: 1. At full load, nominal input, 20 MHz bandwidth oscilloscope, with 1 μ F ceramic and 10 μ F electrolytic capacitors on the output.
 2. At 230 Vac input.
 3. All specifications are measured at Ta=25°C, humidity <75%, nominal input voltage, and rated output load unless otherwise specified.

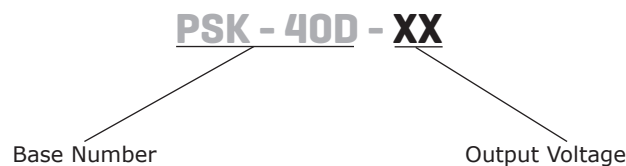
PART NUMBER KEY

INPUT

parameter	conditions/description	min	typ	max	units
voltage	ac input	85		305	Vac
	dc input	100		430	Vdc
frequency		47		63	Hz
current	115 Vac			1.0	A
	230 Vac			0.6	A
inrush current	115 Vac		30		A
	230 Vac		60		A
leakage current	277 Vac/50 Hz			0.1	mA
recommended external input fuse	3.15A/300V, slow-blow, required				

OUTPUT

parameter	conditions/description	min	typ	max	units
capacitive load	5 Vdc output model			6,600	μF
	12 Vdc output model			4,400	μF
	15 Vdc output model			3,000	μF
	24 Vdc output model			1,500	μF
	48 Vdc output model			470	μF
output voltage accuracy			±2		%
line regulation	at full load		±0.5		%
load regulation	0~100% load				
	5 Vdc output model		±2		%
	all other output models		±1		%
hold-up time	115 Vac		8		ms
	230 Vac		50		ms
temperature coefficient			±0.02		%/°C
no load power consumption			0.3		W

PROTECTIONS

parameter	conditions/description	min	typ	max	units
over voltage protection	clamp or hiccup				
	5 Vdc output			6.3	Vdc
	12 Vdc output			16	Vdc
	15 Vdc output			25	Vdc
	24 Vdc output			35	Vdc
	48 Vdc output			60	Vdc
over current protection	auto recovery	130			%
short circuit protection	continuous, auto recovery, hiccup				

SAFETY & COMPLIANCE

parameter	conditions/description	min	typ	max	units
isolation voltage	input to output for 1 min., 5mA max	4,200			Vac
safety approvals	certified to 62368: UL, IEC, EN				
safety class	Class II				
EMI/EMC	CISPR32/EN55032 Class B				
	CISPR32/EN55032 Class B				
ESD	IEC/EN61000-4-2 Contact ±6KV/Air ±8KV, perf. Criteria A				
radiated immunity	IEC/EN61000-4-3 10V/m, perf. Criteria A				
EFT/burst	IEC/EN61000-4-4 ±2KV, perf. Criteria A				
	IEC/EN61000-4-4 ±4KV (See recommended circuit), perf. Criteria A				
surge	IEC/EN61000-4-5 line to line ±2KV/line to PE ±4KV, perf. Criteria A				

SAFETY & COMPLIANCE

parameter	conditions/description	min	typ	max	units
conducted immunity	IEC/EN61000-4-6 10Vrms, perf. Criteria A				
voltage dips and interruption	IEC/EN61000-4-11 0%, 70% perf. Criteria B				
MTBF	MIL-HDBK-217F at 25°C	500,000			hours
RoHS	yes				

ENVIRONMENTAL

parameter	conditions/description	min	typ	max	units
operating temperature		-40		85	°C
storage temperature		-40		85	°C
storage humidity		0		95	%

SOLDERABILITY

parameter	conditions/description	min	typ	max	units
wave soldering	5~10 seconds max	255	260	265	°C
hand soldering	3~5 seconds max	350	360	370	°C

MECHANICAL

parameter	conditions/description	min	typ	max	units
dimensions	69.50 x 39.00 x 24.00				mm
weight			100		g
case material	Black plastic, flame-retardant and heat-resistant (UL94V-0)				
cooling method	natural convection				

MECHANICAL DRAWING

units: mm [inch]
 pin diameter tolerance: ±0.10 [±0.004]
 tolerance: ±0.50 [±0.020]

PIN CONNECTIONS	
PIN	Function
1	AC(L)
2	AC(N)
3	-Vo
4	+Vo

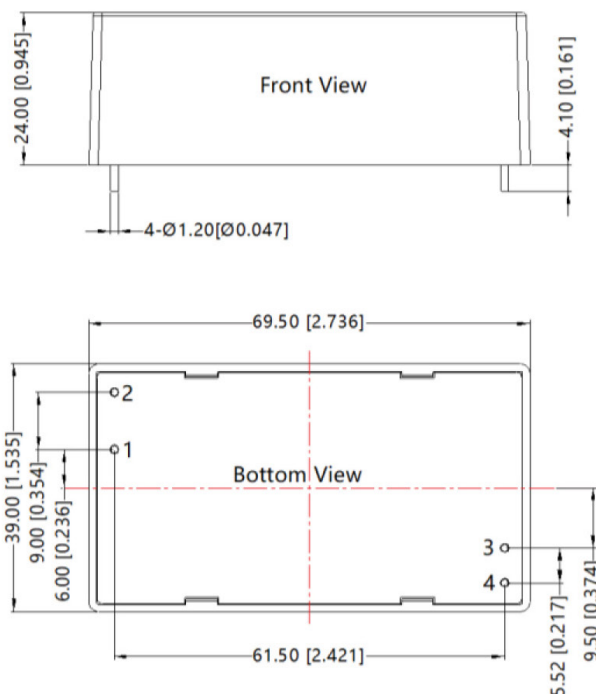

Note: Grid 2.54*2.54mm

DERATING CURVE

TEMPERATURE DERATING CURVE
85~305 Vac
100~430 Vdc

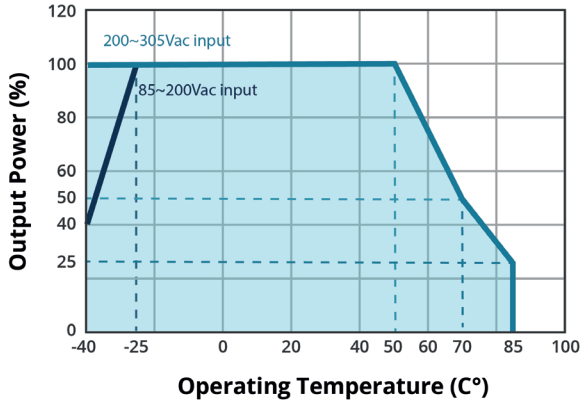

INPUT VOLTAGE DERATING CURVE (25°C)

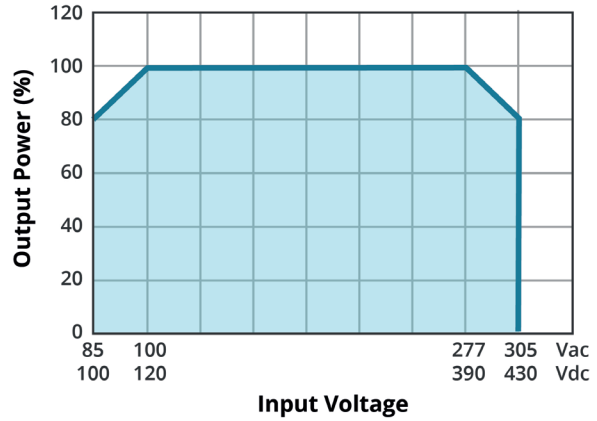

ALTITUDE DERATING CURVE (25°C)

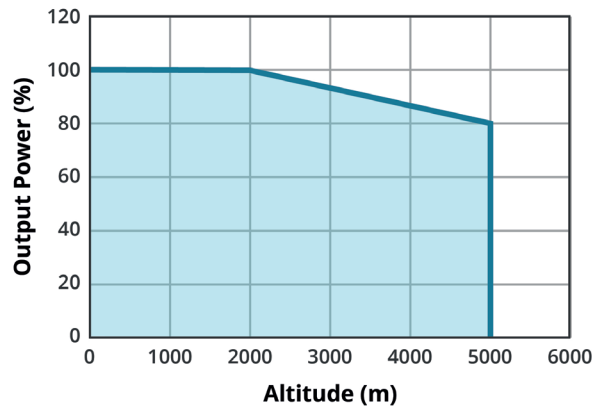

Note: 1. With an AC input between 85~100V/277~305Vac and a DC input between 100~120V/390~430Vdc, the output power must be derated as per temperature derating curves.
2. This product is suitable for applications using natural air cooling; for applications in closed environment please consult with CUI.

EFFICIENCY CURVES

EFFICIENCY VS INPUT VOLTAGE (full load)

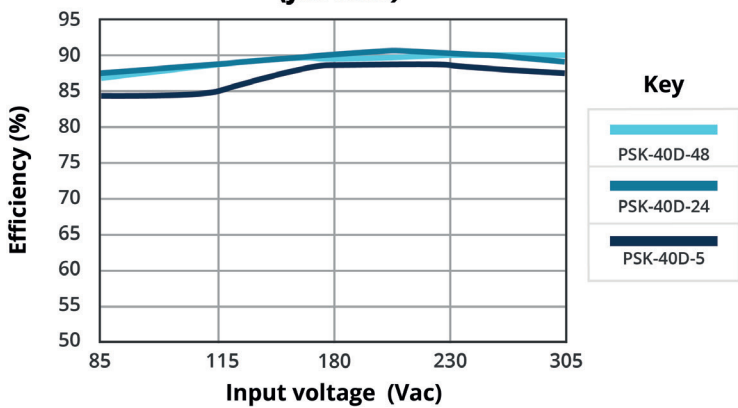

EFFICIENCY VS OUTPUT LOAD (Vin = 230 Vac)

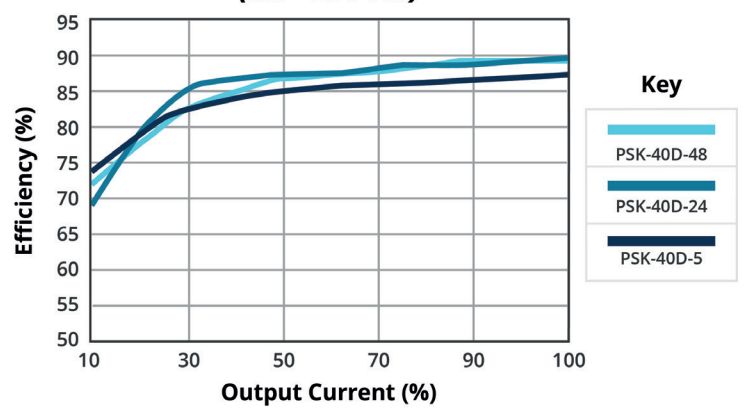

APPLICATION DESIGN REFERENCE

Output Filtering Components:

We recommend using an electrolytic capacitor with high frequency, and low ESR rating for C2 (refer to manufacture’s datasheet). Choose a Capacitor voltage rating with at least 20% margin, in other words not exceeding 80%. C1 is a ceramic capacitor used for filtering high-frequency noise and TVS is a recommended suppressor diode to protect the application in case of a converter failure.

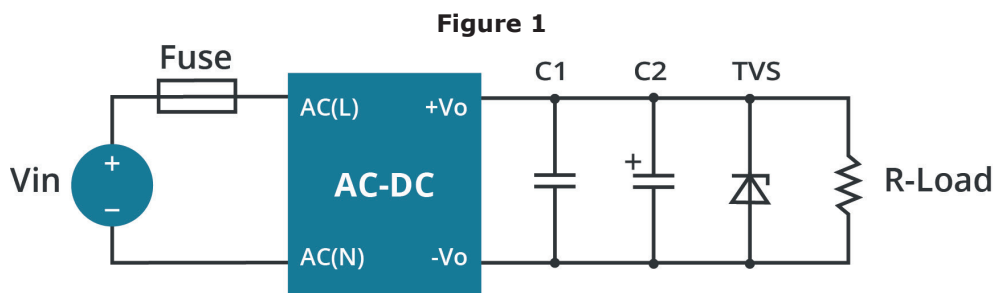
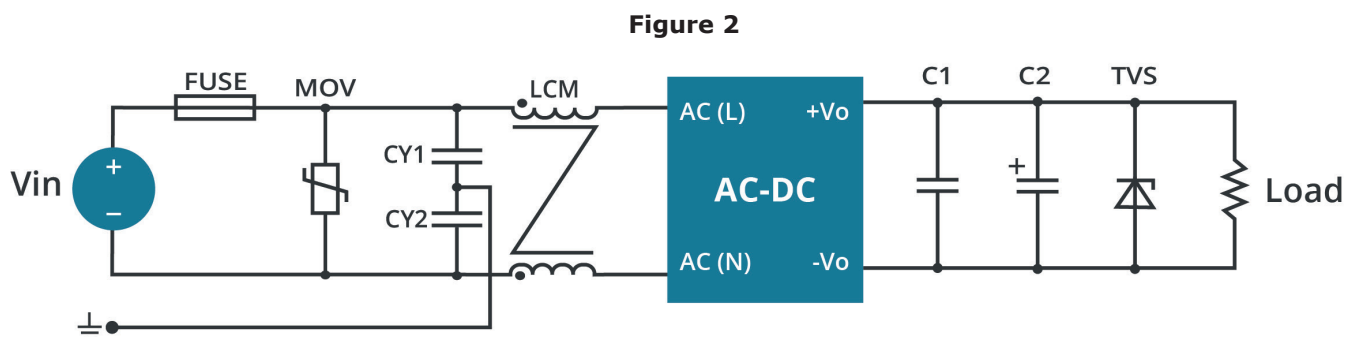

Table 1

Part No.	FUSE	C1	C2	TVS
PSK-40D-5	3.15/300V slow-blow required	1μF/50V	330μF/16V	SMBJ7.0A
PSK-40D-12			330μF/16V	SMBJ20A
PSK-40D-15			220μF/25V	SMBJ20A
PSK-40D-24			100μF/35V	SMBJ30A
PSK-40D-48			47μF/63V	SMBJ64A

EMC RECOMMENDED CIRCUIT



Note: EMC application circuit with higher requirements.

Table 2

Components	Recommended Value
FUSE	3.15A/300V, slow-blow, required
MOV	S14K350
CY1/CY2	1nF/400Vac
LCM	10mH

REVISION HISTORY

rev.	description	date
1.0	initial release	02/15/2023
1.01	safety marks updated	10/31/2023

The revision history provided is for informational purposes only and is believed to be accurate.



Headquarters
20050 SW 112th Ave.
Tualatin, OR 97062
800.275.4899

Fax 503.612.2383
cui.com
techsupport@cui.com

CUI offers a two (2) year limited warranty. Complete warranty information is listed on our website.

CUI reserves the right to make changes to the product at any time without notice. Information provided by CUI is believed to be accurate and reliable. However, no responsibility is assumed by CUI for its use, nor for any infringements of patents or other rights of third parties which may result from its use.

CUI products are not authorized or warranted for use as critical components in equipment that requires an extremely high level of reliability. A critical component is any component of a life support device or system whose failure to perform can be reasonably expected to cause the failure of the life support device or system, or to affect its safety or effectiveness.