

SERIES: SDI120B-U | **DESCRIPTION:** AC-DC POWER SUPPLY

FEATURES

- level VI efficiency
- 120 W power
- universal input (90~264 Vac)
- over voltage, over current, short circuit, and over temperature protections
- UL/cUL, PSE, UKCA safety approvals
- certified to 62368-1 standards
- power factor correction
- -20 ~ 60 °C operation with derating
- 140.5 x 60 x 35 mm case size
- IEC320/C14 ac inlet
- custom designs available



MODEL	output voltage	output current max	output power max	ripple and noise ¹ max	efficiency level
	(Vdc)	(A)	(W)	(mVp-p)	
SDI120B-12-U	12	9	108	120	VI
SDI120B-15-U	15	8	120	150	VI
SDI120B-16-U	16	7.5	120	160	VI
SDI120B-19-U	19	6.3	120	190	VI
SDI120B-24-U	24	5	120	240	VI
SDI120B-48-U	48	2.5	120	480	VI
SDI120B-56-U	56	2.14	120	560	VI

Notes: 1. At full load, nominal input, 20 MHz bandwidth oscilloscope, each output terminated with 0.1 µF multilayer ceramic and 47 µF low ESR electrolytic capacitors.

PART NUMBER KEY

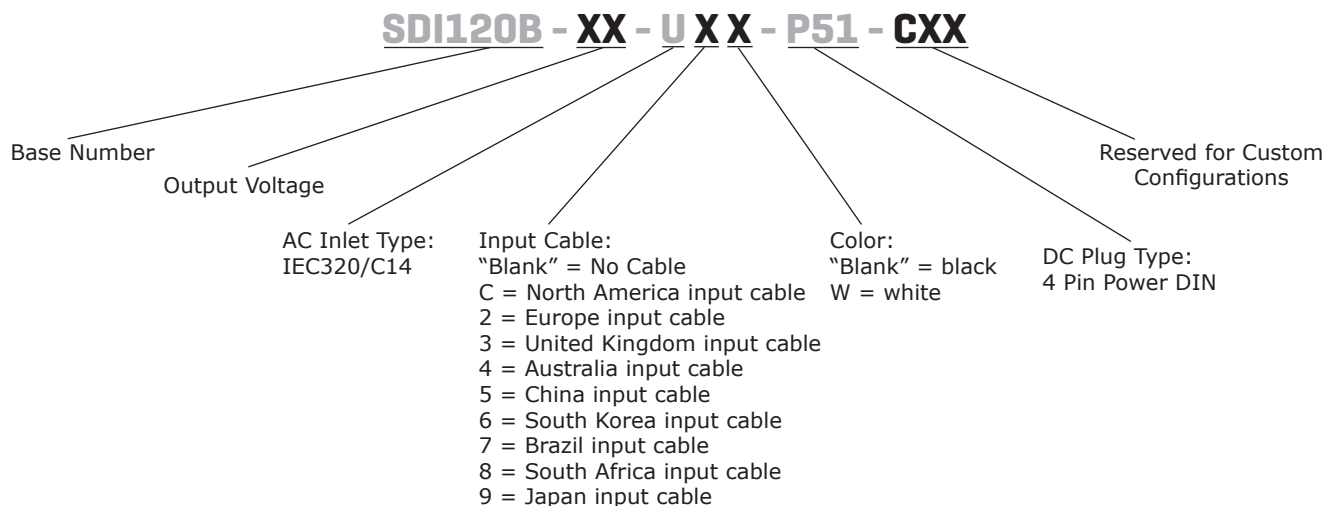

INPUT

parameter	conditions/description	min	typ	max	units
voltage		90	100~240	264	Vac
frequency		47	50~60	63	Hz
current				1.6	A
inrush current	at 230 Vac, full load, 25°C, cold start			100	A
leakage current				3.5	mA
power factor correction	at 115 & 230 Vac, full load	0.9			
no load power consumption	at 115 & 230 Vac, no load			0.21	W

OUTPUT

parameter	conditions/description	min	typ	max	units
regulation			±5		%

PROTECTIONS

parameter	conditions/description	min	typ	max	units
over voltage protection	latch off (50% load)			150	%
over current protection	auto recovery			180	%
short circuit protection	auto recovery				
over temperature protection	auto recovery				

SAFETY & COMPLIANCE

parameter	conditions/description	min	typ	max	units
isolation voltage	input to output at for 1 minute, 10 mA max input to frame ground for 1 minute, 10 mA max		3,000 1,770		Vac
safety approvals	UL / CUL / PSE / UKCA				
EMI/EMC	CE / FCC (conduction & radiation Class B)				
MTBF	as per Telcordia SR-332, 25°C	300,000			hrs
RoHS	yes				

ENVIRONMENTAL

parameter	conditions/description	min	typ	max	units
operating temperature		-20		40	°C
storage temperature		-20		80	°C
operating humidity	non-condensing	20		80	%
storage humidity	non-condensing	10		90	%

DERATING CURVES

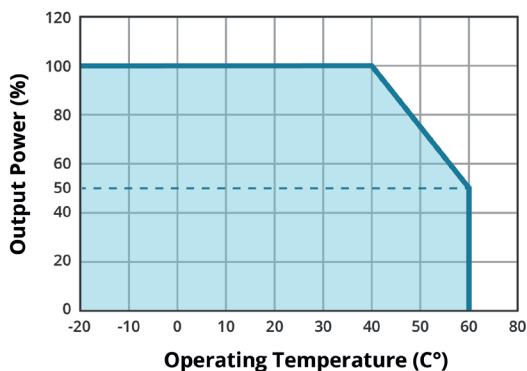
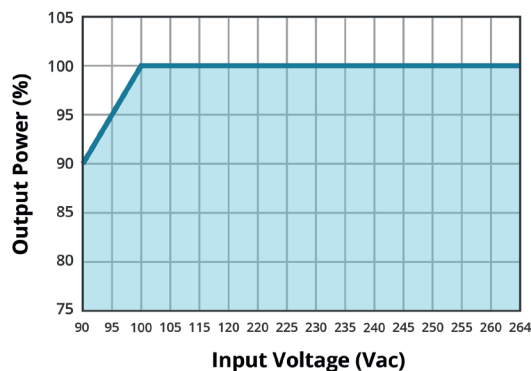
TEMPERATURE DERATING CURVE**INPUT VOLTAGE DERATING CURVE**

MECHANICAL

parameter	conditions/description	min	typ	max	units
dimensions	140.5 x 60.0 x 35.0				mm
inlet plug	IEC320/C14				
weight			390		g

MECHANICAL DRAWING

units: mm
tolerance: ±1.0 mm

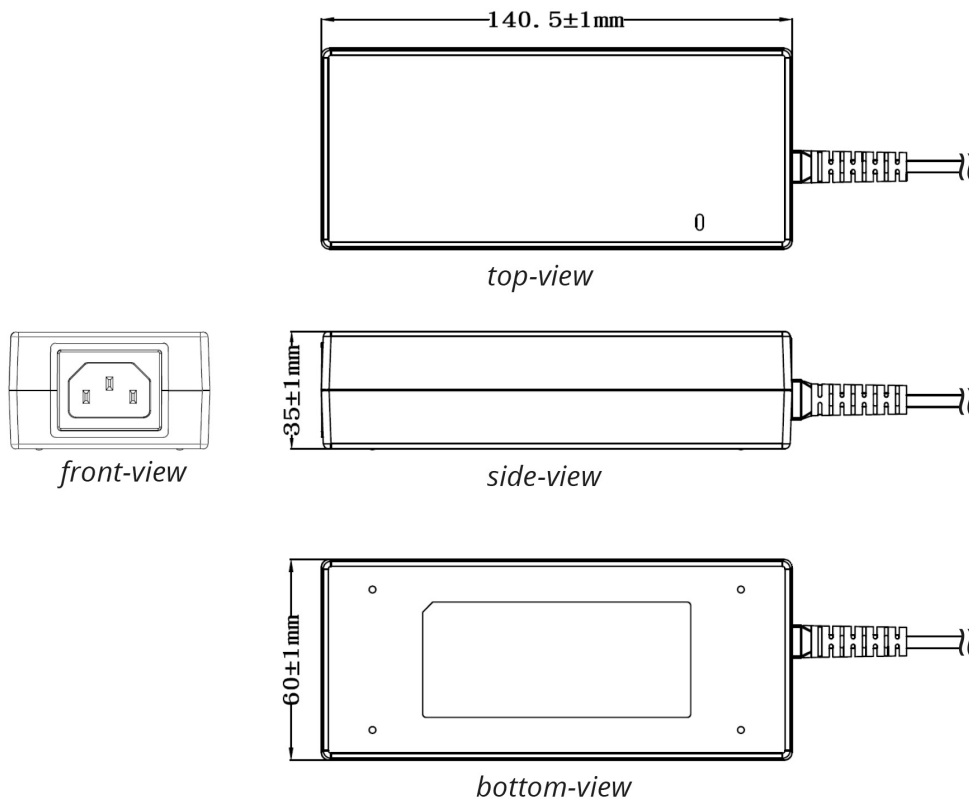

DC CORD

units: mm

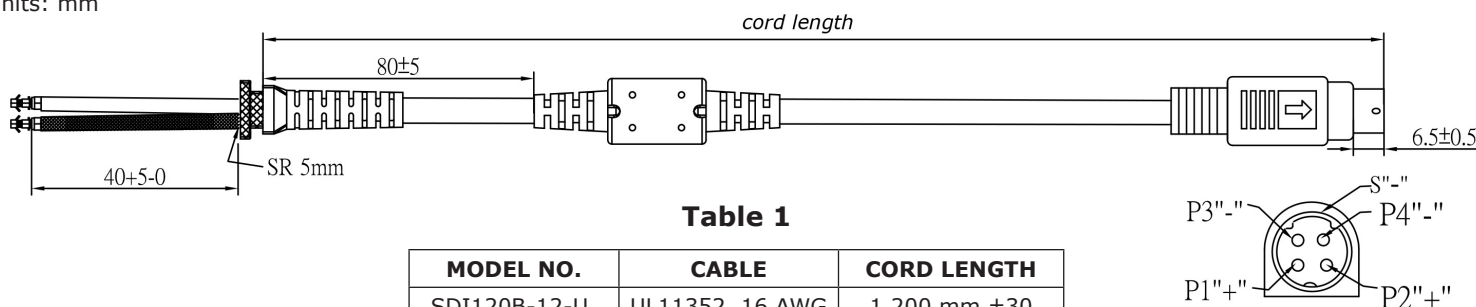

Table 1

MODEL NO.	CABLE	CORD LENGTH
SDI120B-12-U	UL11352, 16 AWG	1,200 mm ±30
SDI120B-15-U	UL11352, 16 AWG	1,500 mm ±30
SDI120B-16-U	UL11352, 16 AWG	1,500 mm ±30
SDI120B-19-U	UL11352, 18 AWG	1,500 mm ±30
SDI120B-24-U	UL11352, 18 AWG	1,500 mm ±30
SDI120B-48-U	UL1185, 18 AWG	1,500 mm ±30
SDI120B-56-U	UL1185, 18 AWG	1,500 mm ±30

AC CORD

units: mm

cord length

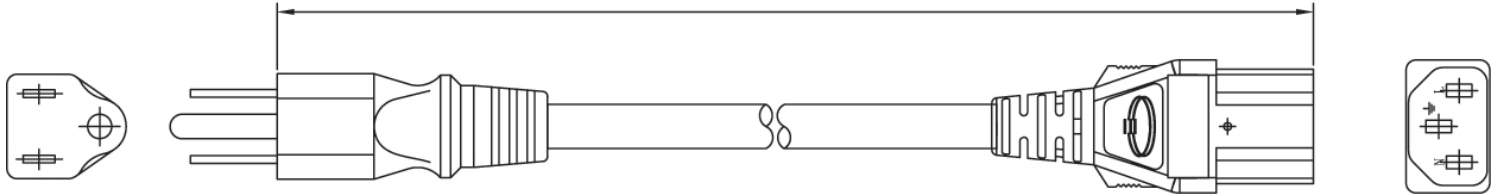

NORTH AMERICA

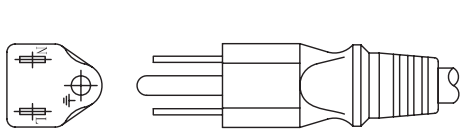

EUROPE

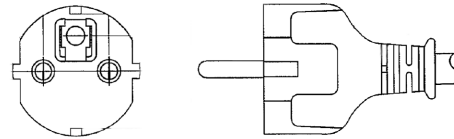

UNITED KINGDOM

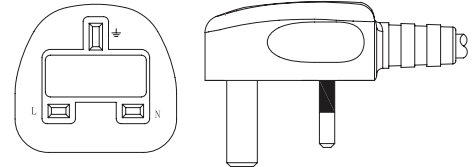

AUSTRALIA

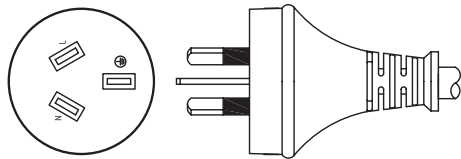

CHINA

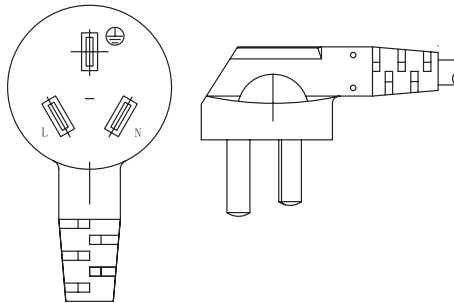

SOUTH KOREA

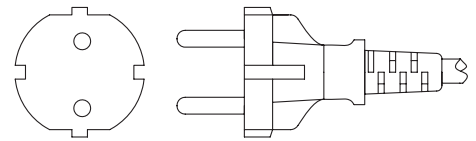

BRAZIL

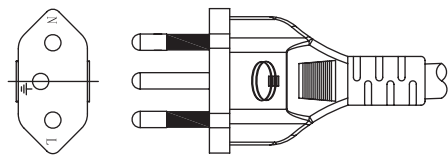

SOUTH AFRICA

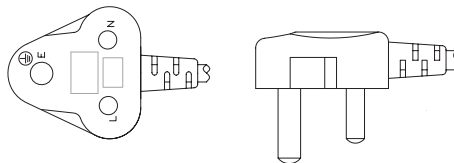

JAPAN

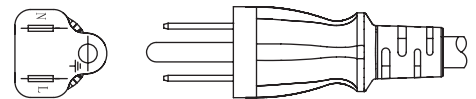

Table 2

AC INPUT	CORD LENGTH
North America	1,830 mm ±30
Europe	1,830 mm ±30
United Kingdom	1,830 mm ±30
Australia	1,830 mm ±30
China	1,830 mm ±30
South Korea	1,830 mm ±50
Brazil	1,830 mm ±30
South Africa	1,830 mm ±50
Japan	1,830 mm ±30

REVISION HISTORY

rev.	description	date
1.0	initial release	10/27/2023

The revision history provided is for informational purposes only and is believed to be accurate.



Headquarters
20050 SW 112th Ave.
Tualatin, OR 97062
800.275.4899

Fax 503.612.2383
cui.com
techsupport@cui.com

This device complies with part 15 of the FCC Rules. Operation is subject to the following two conditions:

- (1) This device may not cause harmful interference, and
- (2) this device must accept any interference received, including interference that may cause undesired operation.

CUI offers a one (1) year limited warranty. Complete warranty information is listed on our website.

CUI reserves the right to make changes to the product at any time without notice. Information provided by CUI is believed to be accurate and reliable. However, no responsibility is assumed by CUI for its use, nor for any infringements of patents or other rights of third parties which may result from its use.

CUI products are not authorized or warranted for use as critical components in equipment that requires an extremely high level of reliability. A critical component is any component of a life support device or system whose failure to perform can be reasonably expected to cause the failure of the life support device or system, or to affect its safety or effectiveness.