

**SERIES:** SWM30-E | **DESCRIPTION:** AC-DC POWER SUPPLY

**FEATURES**

- up to 30 W power
- EN 60601-1 4th edition
- compact design
- universal input (90~264 Vac)
- single regulated output from 5~48 Vdc
- over voltage and short circuit protections
- DOE Level VI / CoC Tier 2 efficiency
- 2 MOPP compliant



MODEL	output voltage	output current	output power	ripple and noise <sup>1</sup>	efficiency level <sup>2</sup>
	(Vdc)	max (A)	max (W)	max (mVp-p)	
SWM30-5-EV	5	4.0	20	100	VI
SWM30-9-EV	9	3.0	27	180	VI
SWM30-12-EV	12	3.0	36	250	VI
SWM30-15-EV	15	2.0	30	250	VI
SWM30-18-EV	18	1.66	30	350	VI
SWM30-24-EV	24	1.50	36	350	VI
SWM30-36-EV	36	0.83	30	480	VI
SWM30-48-EV	48	0.62	30	480	VI

Notes: 1. At full load, 100 ~ 240 Vac input, 20 MHz bandwidth oscilloscope, output terminated with a low ESR 47 µF electrolytic and 0.1 µF multilayer capacitor.  
2. CoC Tier 2 compliant.

**PART NUMBER KEY**

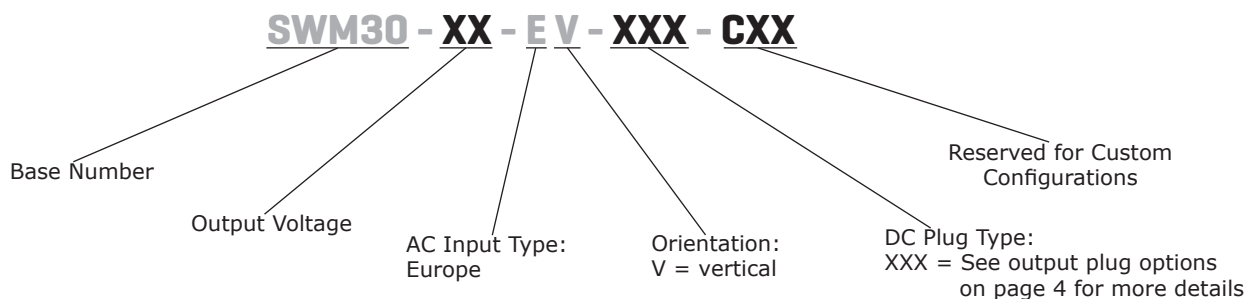

## INPUT

parameter	conditions/description	min	typ	max	units
voltage		90		264	Vac
frequency		47		63	Hz
current	at 115 Vac, full load at 230 Vac, full load			0.6 0.3	A A
inrush current	at 115 Vac, full load, cold start at 230 Vac, full load, cold start			30 60	A A
leakage current	at 240 Vac, 50 Hz			0.1	mA
no load power consumption	at 115/230 Vac, 60/50 Hz			0.075	W

## OUTPUT

parameter	conditions/description	min	typ	max	units
line regulation			±1		%
load regulation			±5		%
start-up time	at 220 Vac, to 90% of rated output voltage			3	s
rise time	at nominal input voltage, full load, from 10% to 90% of output voltage			50	ms
hold-up time	at nominal input voltage, full load	8.3			ms

## PROTECTIONS

parameter	conditions/description	min	typ	max	units
over voltage protection	output shutdown, auto recovery				
over current protection	output shutdown, auto recovery			200	%
short circuit protection	output shut down, auto recovery				

## SAFETY & COMPLIANCE

parameter	conditions/description	min	typ	max	units
isolation voltage	input to output		4,000		Vac
isolation resistance	input to output at 500 Vdc for 3 seconds	50			MΩ
safety approvals	medical TUV EN 60601-1				
EMI/EMC	CE				
MTBF	as per MIL-HDBK-217F	100,000			hours
RoHS	2011/65/EU				

## ENVIRONMENTAL

parameter	conditions/description	min	typ	max	units
operating temperature		0		40	°C
storage temperature		-20		85	°C
operating humidity	non-condensing	10		90	%
storage humidity	non-condensing	5		90	%
altitude			5,000		m

## MECHANICAL

parameter	conditions/description	min	typ	max	units
dimensions	76 x 43 x 48				mm
inlet plug	Europe				
weight			200		g
color	black				

## MECHANICAL DRAWING

units: mm  
tolerance:  $\pm 1$  mm

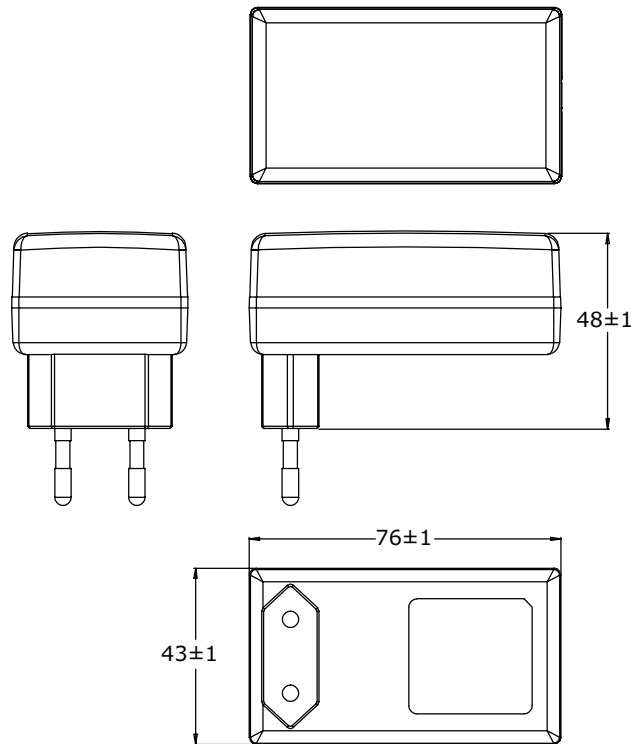

## DC CORD

units: mm

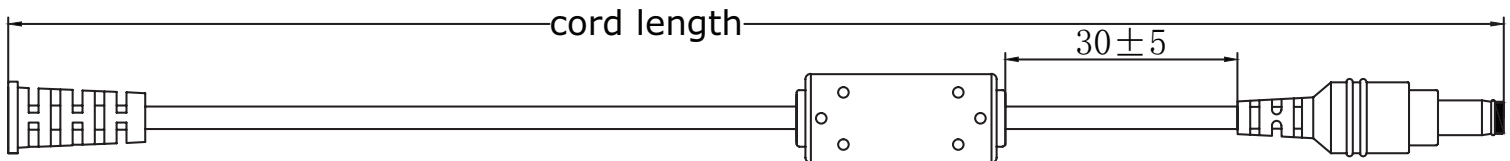



**Table 1**

MODEL NO.	CABLE	CORD LENGTH
SWM30-5-EV	UL1185, 16 AWG	1,200 mm $\pm 30$
SWM30-9-EV	UL1185, 16 AWG	1,200 mm $\pm 30$
SWM30-12-EV	UL1185, 16 AWG	1,200 mm $\pm 30$
SWM30-15-EV	UL1185, 16 AWG	1,200 mm $\pm 30$
SWM30-18-EV	UL1185, 18 AWG	1,200 mm $\pm 30$
SWM30-24-EV	UL1185, 18 AWG	1,200 mm $\pm 30$
SWM30-36-EV	UL1185, 18 AWG	1,200 mm $\pm 30$
SWM30-48-EV	UL1185, 18 AWG	1,200 mm $\pm 30$

## DC PLUG TYPE PART NUMBER KEY

**XXX**

**Plug Polarity:**  
 P = Center Positive  
  
 N = Center Negative  

**Plug Code:**  
 X = Choose a code from the options below

**Plug Angle:**  
 "blank" = Straight  
 R = Right Angle

Plug Polarity		Code		Dimensions (mm)			Plug Angle	
Center Pos.	Center Neg.	Option	Type	A	B	C	Straight	Right
•	•	5	Standard	5.5	2.1	9.5	•	•
•	•	6	Standard	5.5	2.5	9.5	•	•
•	•	7	Standard	3.5	1.35	9.5	•	•
•	•	8	Standard	3.8	1.35	9.5	•	•
•	•	9	Standard	3.8	1.05	9.5	•	•
•	•	12	EIAJ-1	2.35	0.7	9.5	•	•
•	•	13	EIAJ-2	4.0	1.7	9.5	•	•
•	•	14	EIAJ-3	4.75	1.7	9.5	•	•
N/A	N/A	ST	Stripped & Tinned			N/A	N/A	

Note: 1. Contact CUI for additional plug options

### Standard

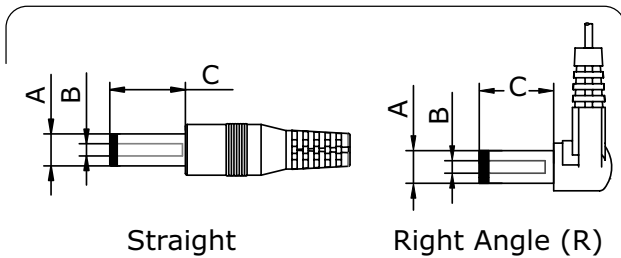

### EIAJ

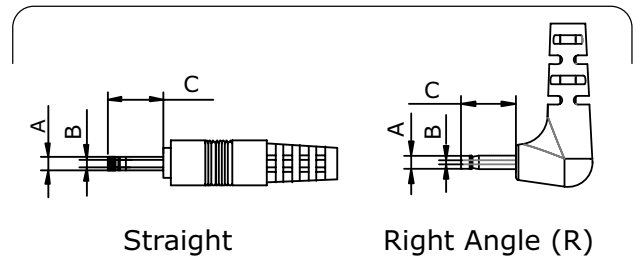

### Stripped & Tinned

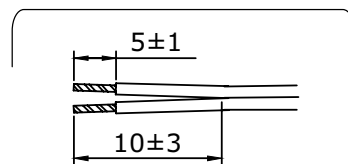

## REVISION HISTORY

---

rev.	description	date
1.0	initial release	06/27/2017
1.01	company logo updated	08/25/2020

The revision history provided is for informational purposes only and is believed to be accurate.



**CUI INC**

a bel group

**Headquarters**  
20050 SW 112th Ave.  
Tualatin, OR 97062  
**800.275.4899**

Fax 503.612.2383  
**cui.com**  
techsupport@cui.com

This device complies with part 15 of the FCC Rules. Operation is subject to the following two conditions:

- (1) This device may not cause harmful interference, and
- (2) this device must accept any interference received, including interference that may cause undesired operation.

CUI offers a one (1) year limited warranty. Complete warranty information is listed on our website.

CUI reserves the right to make changes to the product at any time without notice. Information provided by CUI is believed to be accurate and reliable. However, no responsibility is assumed by CUI for its use, nor for any infringements of patents or other rights of third parties which may result from its use.

CUI products are not authorized or warranted for use as critical components in equipment that requires an extremely high level of reliability. A critical component is any component of a life support device or system whose failure to perform can be reasonably expected to cause the failure of the life support device or system, or to affect its safety or effectiveness.