



SERIES: ETMA 60W UD | **DESCRIPTION:** MEDICAL AC-DC POWER SUPPLY

FEATURES

- up to 60 W power
- universal input (90~264 Vac)
- single regulated output from 12~48 Vdc
- over voltage and short circuit protections
- medical 60601-1 4th edition safety approvals
- designed for 2 x MOPP applications
- level V efficiency
- custom designs available



MODEL	output voltage (Vdc)	output current max (A)	output power max (W)	ripple and noise ¹ max (mVp-p)	efficiency level
ETMA120500UD	12	5	60	120	V
ETMA150400UD	15	4	60	150	V
ETMA180333UD	18	3.33	60	180	V
ETMA240250UD	24	2.5	60	240	V
ETMA360166UD	36	1.66	60	360	V
ETMA480125UD	48	1.25	60	480	V

Notes: 1. At full load, 100 ~ 240 Vac input, 20 MHz bandwidth oscilloscope, each output terminated with 10 µF aluminum electrolytic and 0.1 µF ceramic capacitors.

PART NUMBER KEY

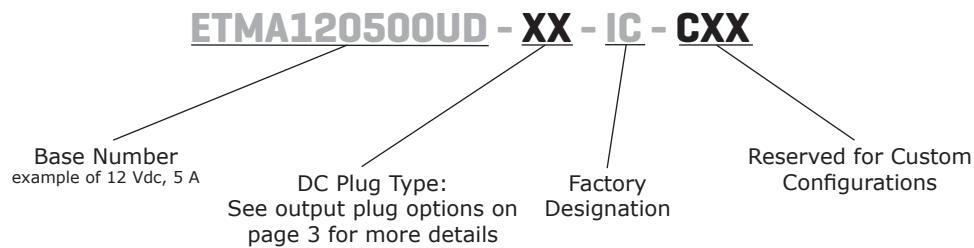

INPUT

parameter	conditions/description	min	typ	max	units
voltage		90		264	Vac
frequency		47		63	Hz
inrush current	at 240 Vac			80	A
no load power consumption				0.3	W

OUTPUT

parameter	conditions/description	min	typ	max	units
line regulation ¹			±1		%
load regulation ²	12 Vdc output		±5		%
	15 Vdc output		±3		%
	all other outputs		±2		%
voltage accuracy			±2		%
hold-up time	at 115 Vac		8		ms
switching frequency			100		kHz
temperature coefficient			±0.05		%/°C

Note: 1. measured from 100 ~ 240 Vac, full load
2. measured from 60% to full load and from 60 ~ 20% load (60% ±40% load)

PROTECTIONS

parameter	conditions/description	min	typ	max	units
over voltage protection	TVS component to clamp				
short circuit protection	continuous, auto restart				

SAFETY & COMPLIANCE

parameter	conditions/description	min	typ	max	units
isolation voltage	input to output			5,656	Vdc
safety approvals	medical IEC 60601-1, EN 60601-1, UL 60601-1 4th edition				
EMI/EMC	EN 55011, EN 60601-1-2, EN 61000-3-(2,3)				
leakage current				0.1	mA
MTBF	as per MIL-HDBK-217F, 115 Vac, 25 °C	200,000			hours
RoHS	2011/65/EU				

ENVIRONMENTAL

parameter	conditions/description	min	typ	max	units
operating temperature		0		40	°C
storage temperature		-20		85	°C
humidity	non-condensing			93	%

MECHANICAL

parameter	conditions/description	min	typ	max	units
dimensions	132 x 58 x 30.5 (5.2 x 2.28 x 1.2 inch)				mm
input plug	IEC320 / C8				
weight			345		g

MECHANICAL DRAWING

units: mm

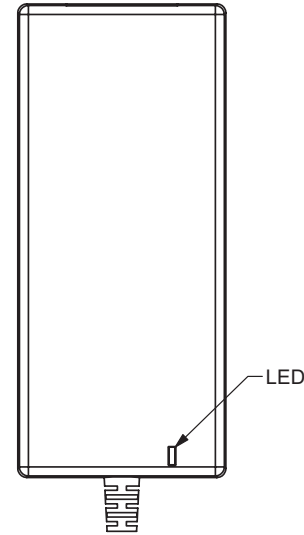
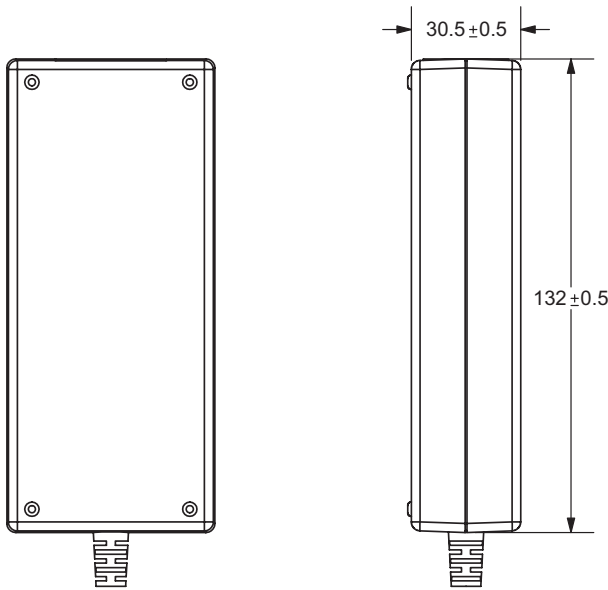
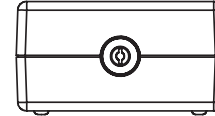
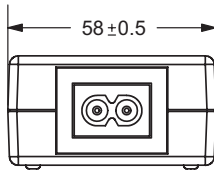

DC OUTPUT PLUG OPTIONS / DC CORD

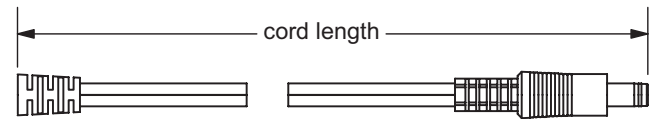
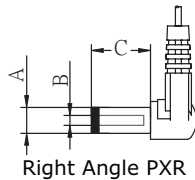
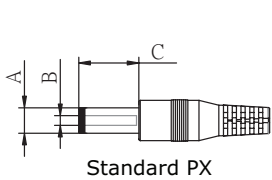

	A	B	C	Unit
P5/P5R	5.5	2.1	9.5	mm
P6/P6R	5.5	2.5	9.5	mm

MODEL NO.	CABLE GAUGE	CORD LENGTH
ETMA120500UD	16 AWG	720 mm ±50
ETMA150400UD	16 AWG	1,220 mm ±50
ETMA180333UD	16 AWG	1,500 mm ±50
ETMA240250UD	16 AWG	1,800 mm ±50
ETMA360166UD	16 AWG	1,800 mm ±50
ETMA480125UD	16 AWG	1,800 mm ±50

PXXX

Plug Type

Plug Angle:
"Blank" = Standard
R = Right Angle

Plug Polarity:
"Blank" = N/A
P = Center Positive

N = Center Negative

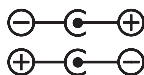

REVISION HISTORY

rev.	description	date
1.0	initial release	12/16/2011
1.01	updated P7/P7R B dimension	03/23/2012
1.02	V-Infinity branding removed	08/21/2012
1.03	updated datasheet	10/31/2012
1.04	corrected dc cord table	07/02/2013
1.05	updated datasheet	07/10/2015
1.06	updated to medical 60601-1 4th edition	06/20/2017

The revision history provided is for informational purposes only and is believed to be accurate.



Headquarters
 20050 SW 112th Ave.
 Tualatin, OR 97062
800.275.4899

Fax 503.612.2383
cui.com
 techsupport@cui.com

This device complies with part 15 of the FCC Rules. Operation is subject to the following two conditions:

- (1) This device may not cause harmful interference, and
- (2) this device must accept any interference received, including interference that may cause undesired operation.

CUI offers a one (1) year limited warranty. Complete warranty information is listed on our website.

CUI reserves the right to make changes to the product at any time without notice. Information provided by CUI is believed to be accurate and reliable. However, no responsibility is assumed by CUI for its use, nor for any infringements of patents or other rights of third parties which may result from its use.

CUI products are not authorized or warranted for use as critical components in equipment that requires an extremely high level of reliability. A critical component is any component of a life support device or system whose failure to perform can be reasonably expected to cause the failure of the life support device or system, or to affect its safety or effectiveness.