



Part No: GF1004M

Date: 9/20/2006

Unit: mm

Description: speaker

Page No: 1 of 2



Specifications

Nominal Size	102 mm (4.00 in)	(See attached drawing)
Impedance	8 Ohm \pm 15%	at 600 Hz 1 V
Resonant frequency	230 Hz \pm 46 Hz	at 1 V
Sound pressure level	93 dB/w \pm 2 dB	1 w 50 cm ave. at 0.4K, 0.5K, 0.6K, 0.8K Hz
Response	Fo Hz ~ 14 KHz max 10 dB	
Input power	Nominal 6 W	Handling capacity 10 W
Operation	must be normal at program source 6 W	
Buzz, rattle, etc.	must be normal at sine wave 6.9 V	
Magnet	Size: 55 x 25 x 8 mm	
Load test	White noise 6 W	for 48 hours
Heat test	70 \pm 2° C	20-50% R.H. 48 hours
Humidity test	40 \pm 2° C	90-95% R.H. 48 hours

Frequency Response Curve

Potentiometer range	50 dB
Rectifier	RMS
Lower limit frequency	20 Hz
Wr. speed	100 mm/sec

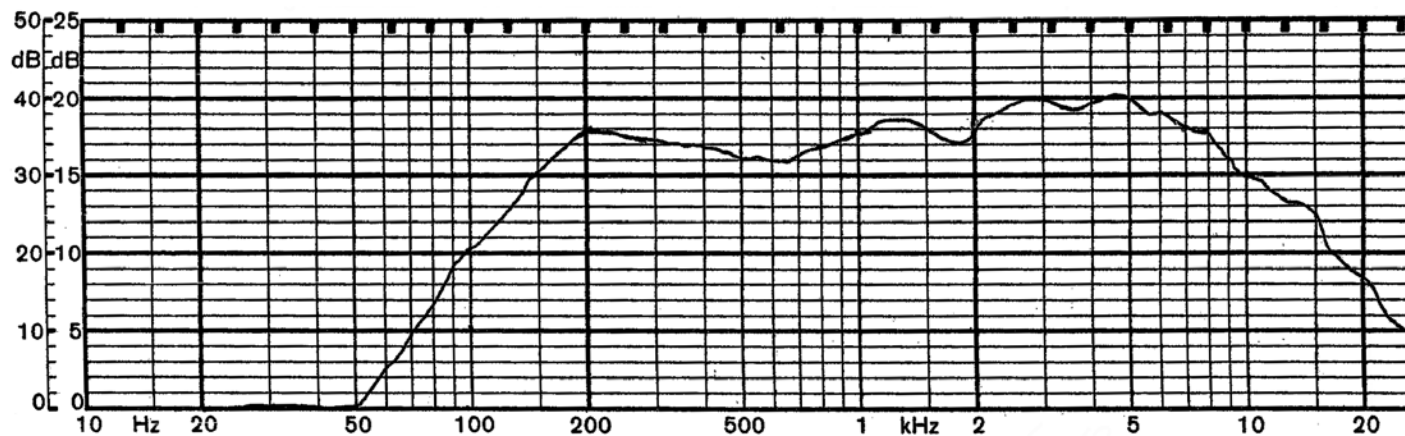
Zero level 60 dB

REV.	DESCRIPTION	DATE
A	NEW DRAWING	8/8/2006

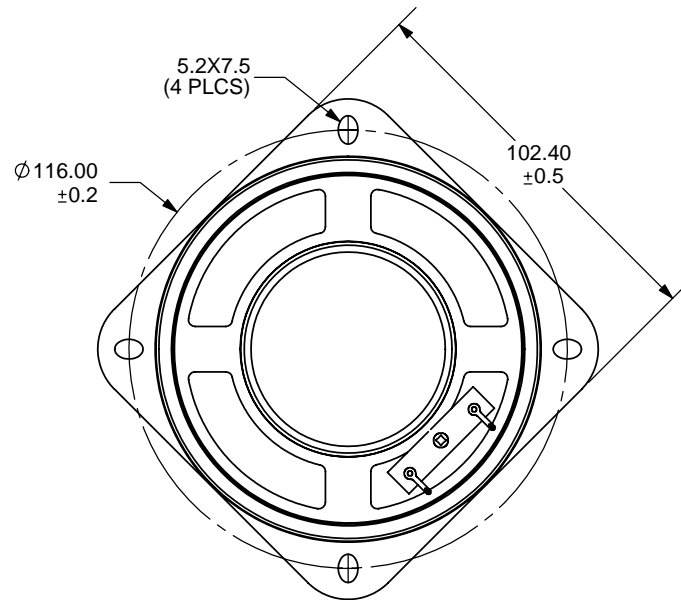
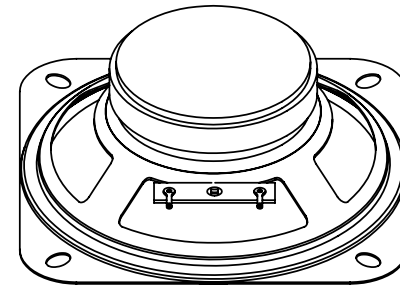
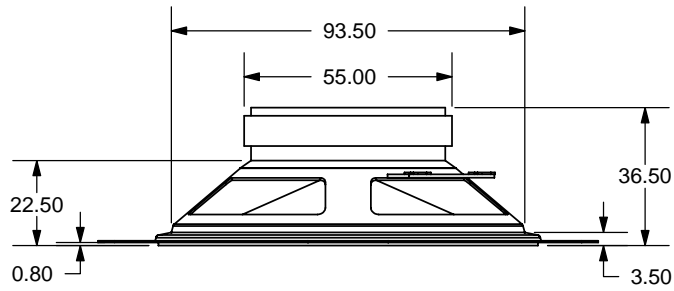

TOLERANCE:
±0.5mm UNLESS OTHERWISE
SPECIFIED



20050 SW 112th Ave.
Tualatin, OR 97062
Phone: 503-643-4899
800-275-4899
Fax: 503-372-1266
Website: www.cui.com

TITLE: Square frame mylar cone - ferrite magnet		REV: A
PART NO. GF1004M	UNITS: MM [INCHES]	
DRAWN BY: ZRJ	APPROVED BY:	SCALE: 1:2

PC FILE NAME:
GF1004M

COPYRIGHT 2006 BY CUI INC.