

REV.	DESCRIPTION	DATE
A	NEW DRAWING	7/08/2008

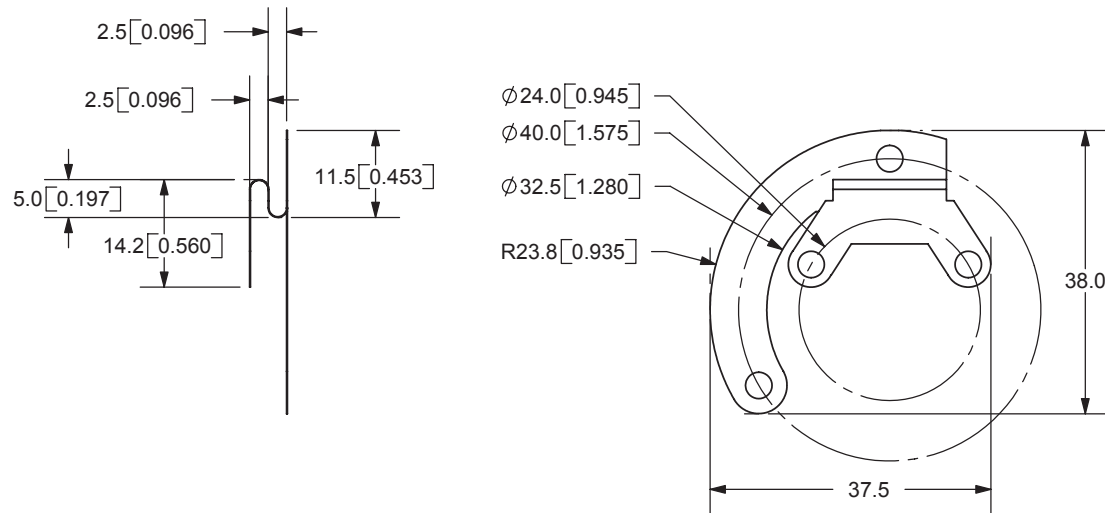

TOLERANCE:
±0.3mm UNLESS OTHERWISE
SPECIFIED



20050 SW 112th Ave.
Tualatin, OR 97062
Phone: 503-612-2300
800-275-4899
Fax: 503-612-2383
Website: www.cui.com

TITLE: spring flange		REV: A
PART NO: MEH20SP spring flange	UNITS: MM [INCHES]	
DRAWN BY: JMS	APPROVED BY:	SCALE: 1:1