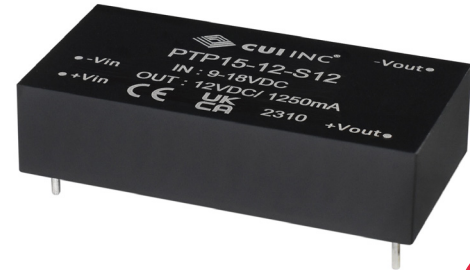

**SERIES:** PTP15 | **DESCRIPTION:** DC-DC CONVERTER**FEATURES**

- up to 15W continuous power
- 2:1 input range (9~18, 18~36 and 36~75 Vdc)
- 5,600 Vdc isolation
- regulated single outputs
- certified to IEC/EN 60601-1
- EN 55011 Class A without external components
- -40 to +100 C operating temperature
- output over current, short circuit and over voltage protections

**MODEL**

| MODEL        | input voltage |                | output voltage<br>(Vdc) | output current<br>max<br>(mA) | output power<br>max<br>(W) | ripple and noise <sup>1</sup><br>max<br>(mVp-p) | efficiency <sup>2</sup><br>typ<br>(%) |
|--------------|---------------|----------------|-------------------------|-------------------------------|----------------------------|---|---------------------------------------|
|              | typ<br>(Vdc)  | range<br>(Vdc) |                         |                               |                            |   |                                       |
| PTP15-12-S5  | 12            | 9~18           | 5                       | 3,000                         | 15                         | 60  | 85                                    |
| PTP15-12-S12 | 12            | 9~18           | 12                      | 1,250                         | 15                         | 60  | 88                                    |
| PTP15-12-S15 | 12            | 9~18           | 15                      | 1,000                         | 15                         | 60  | 87                                    |
| PTP15-12-S24 | 12            | 9~18           | 24                      | 625                           | 15                         | 120   | 85                                    |
| PTP15-24-S5  | 24            | 18~36          | 5                       | 3,000                         | 15                         | 60  | 87                                    |
| PTP15-24-S12 | 24            | 18~36          | 12                      | 1,250                         | 15                         | 60  | 87                                    |
| PTP15-24-S15 | 24            | 18~36          | 15                      | 1,000                         | 15                         | 60  | 87                                    |
| PTP15-24-S24 | 24            | 18~36          | 24                      | 625                           | 15                         | 120   | 87                                    |
| PTP15-48-S5  | 48            | 36~75          | 5                       | 3,000                         | 15                         | 60  | 87                                    |
| PTP15-48-S12 | 48            | 36~75          | 12                      | 1,250                         | 15                         | 60  | 88                                    |
| PTP15-48-S15 | 48            | 36~75          | 15                      | 1,000                         | 15                         | 60  | 87                                    |
| PTP15-48-S24 | 48            | 36~75          | 24                      | 625                           | 15                         | 120   | 88                                    |

Note: 1. Measured at 20 MHz bandwidth with 0.1  $\mu$ F capacitor.  
 2. The efficiency is test by nominal input and max full load at 25°C, the tolerance for the efficiency measurement is plus and minus 2%~3%.  
 3. All specifications are measured at Ta=25°C, nominal input voltage and full output load unless otherwise specified.

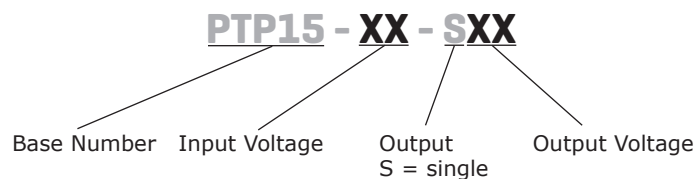
**PART NUMBER KEY**

## INPUT

| parameter               | conditions/description          | min | typ | max | units |
|-------------------------|---------------------------------|-----|-----|-----|-------|
| operating input voltage | 12 Vdc input models             | 9   | 12  | 18  | Vdc   |
|                         | 24 Vdc input models             | 18  | 24  | 36  | Vdc   |
|                         | 48 Vdc input models             | 36  | 48  | 75  | Vdc   |
| current                 | 12 Vdc input models, at no load |     | 10  |     | mA    |
|                         | 24 Vdc input models, at no load |     | 7   |     | mA    |
|                         | 48 Vdc input models, at no load |     | 5   |     | mA    |
| under voltage lockout   | 12 Vdc input models             |     | 7.5 |     | Vdc   |
|                         | 24 Vdc input models             |     | 15  |     | Vdc   |
|                         | 48 Vdc input models             |     | 33  |     | Vdc   |
| surge voltage           | at 1 second max                 |     |     |     |       |
|                         | 12 Vdc input models             |     |     | 25  | Vdc   |
|                         | 24 Vdc input models             |     |     | 50  | Vdc   |
|                         | 48 Vdc input models             |     |     | 100 | Vdc   |
| filter                  | pi filter                       |     |     |     |       |

## OUTPUT

| parameter               | conditions/description                     | min | typ | max   | units |
|-------------------------|--|-----|-----|-------|-------|
| capacitive load         | 5 Vdc output models                        |     |     | 5,600 | μF    |
|                         | 12 Vdc output models                       |     |     | 1,000 | μF    |
|                         | 15 Vdc output models                       |     |     | 720   | μF    |
|                         | 24 Vdc output models                       |     |     | 220   | μF    |
| line regulation         | input voltage from low to high, full load  |     |     | ±0.5  | %     |
| load regulation         | 0% to full load                            |     |     | ±0.5  | %     |
| voltage accuracy        |  |     |     | ±1    | %     |
| start-up time           | at nominal input, full load                |     |     | 25    | ms    |
| switching frequency     | 24 & 48 Vdc input, 5 Vdc output models     |     | 210 |       | KHz   |
|                         | 12 & 24 Vdc input, all other output models |     | 300 |       | KHz   |
|                         | 48 Vdc input, all other output models      |     | 350 |       | KHz   |
| transient recovery time | 75%~100% load step change                  |     |     | 500   | μs    |

## PROTECTIONS

| parameter                | conditions/description          | min  | typ | max  | units |
|--------------------------|---------------------------------|------|-----|------|-------|
| over current protection  |                                 |      | 150 |      | %     |
| over voltage protection  | output clamped with zener diode |      |     |      |       |
|                          | 5 Vdc output models             | 5.6  |     | 8.0  | Vdc   |
|                          | 12 Vdc output models            | 13.4 |     | 19.2 | Vdc   |
|                          | 15 Vdc output models            | 16.8 |     | 24.0 | Vdc   |
|                          | 24 Vdc output models            | 26.9 |     | 38.4 | Vdc   |
| short circuit protection | auto recovery, continuous       |      |     |      |       |

## SAFETY AND COMPLIANCE

| parameter                   | conditions/description                                | min    | typ | max | units |
|-----------------------------|---|--------|-----|-----|-------|
| isolation voltage           |   | 4,000  |     |     | Vac   |
|                             |   | 5,600  |     |     | Vdc   |
| isolation capacitance       |   |        |     | 100 | pF    |
| isolation resistance        |   | 10,000 |     |     | MΩ    |
| safety approvals            | certified to 60601-1: IEC, EN                         |        |     |     |       |
| EMI <sup>4</sup>            | EN 55011 Class A                                      |        |     |     |       |
| ESD                         | EN 61000-4-2, Contact±8kV, Air±15kV, perf. Criteria A |        |     |     |       |
| radiated immunity           | EN 61000-4-3, 10V/m, perf. Criteria A                 |        |     |     |       |
| fast transient <sup>5</sup> | EN 61000-4-4, ±2kV, perf. Criteria A                  |        |     |     |       |

## SAFETY AND COMPLIANCE

| parameter               | conditions/description                     | min                 | typ | max | units          |
|-------------------------|--|---------------------|-----|-----|----------------|
| surge <sup>5</sup>      | EN 61000-4-5, ±2kV, perf. Criteria A       |                     |     |     |                |
| criteria immunity       | EN 61000-4-6, 10 Vrms, perf. Criteria A    |                     |     |     |                |
| magnetic field immunity | EN 61000-4-8, 10A/m, perf. Criteria A      |                     |     |     |                |
| MTBF                    | as per MIL-HDBK-217F<br>at 25°C<br>at 51°C | 1,060,000<br>84,000 |     |     | hours<br>hours |
| RoHS compliant          | yes  |                     |     |     |                |

Note: 4. EMI Class A without external circuit.  
5. Test with E-CAP 220µF/100V at input terminal.

## ENVIRONMENTAL

| parameter             | conditions/description | min | typ | max | units |
|-----------------------|------------------------|-----|-----|-----|-------|
| operating temperature | see derating curve     | -40 |     | 100 | °C    |
| storage temperature   |                        | -55 |     | 105 | °C    |
| storage humidity      | non-condensing         | 5   |     | 95  | %     |

## MECHANICAL

| parameter        | conditions/description | min | typ | max | units |
|------------------|------------------------|-----|-----|-----|-------|
| dimensions       | 50.8 x 25.4 x 12.0     |     |     |     | mm    |
| weight           |                        |     | 30  |     | g     |
| cooling method   | natural convection     |     |     |     |       |
| case material    | plastic case           |     |     |     |       |
| potting material | silicon                |     |     |     |       |

## MECHANICAL DRAWING

units: mm  
tolerance: ±0.25 mm

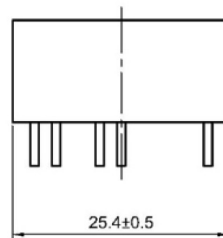
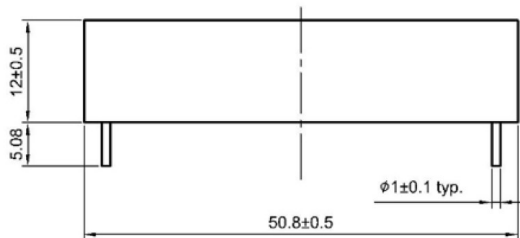

| PIN CONNECTIONS |          |
|-----------------|----------|
| PIN             | Function |
| 1               | +Vin     |
| 2               | -Vin     |
| 3               | +Vout    |
| 4               | no pin   |
| 5               | -Vout    |

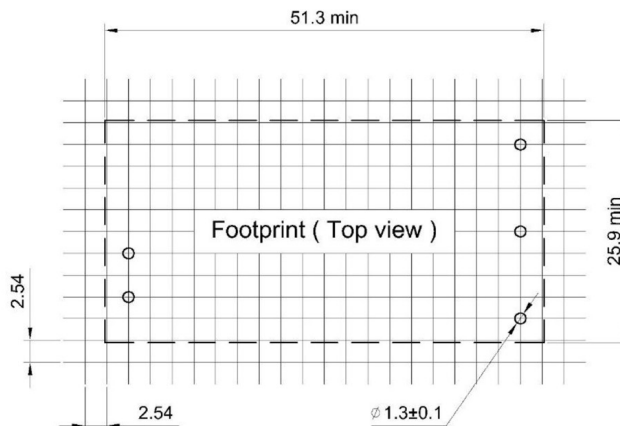
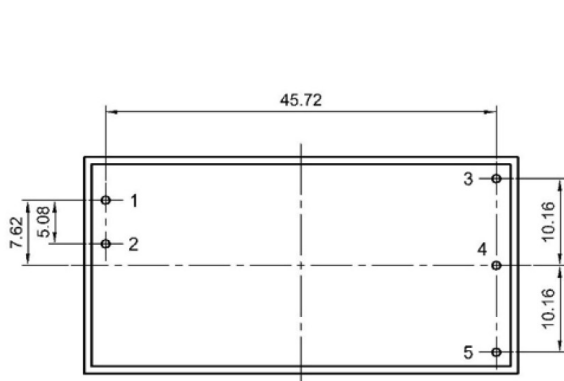

## DERATING CURVES

**TEMPERATURE DERATING CURVE  
(12 & 24 Vdc input models)**

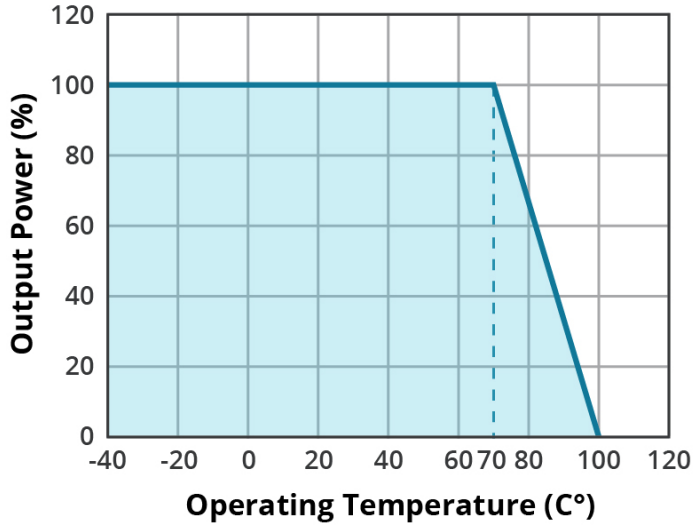

**TEMPERATURE DERATING CURVE  
(48 Vdc input models)**

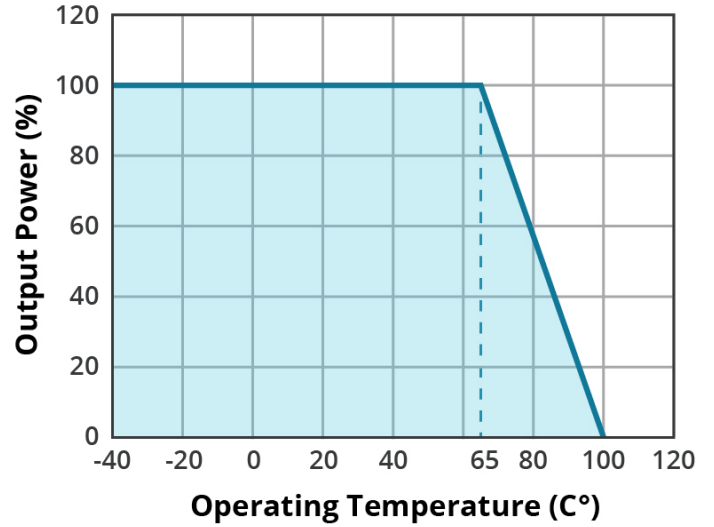

## RIPPLE AND NOISE MEASURE

Figure 1

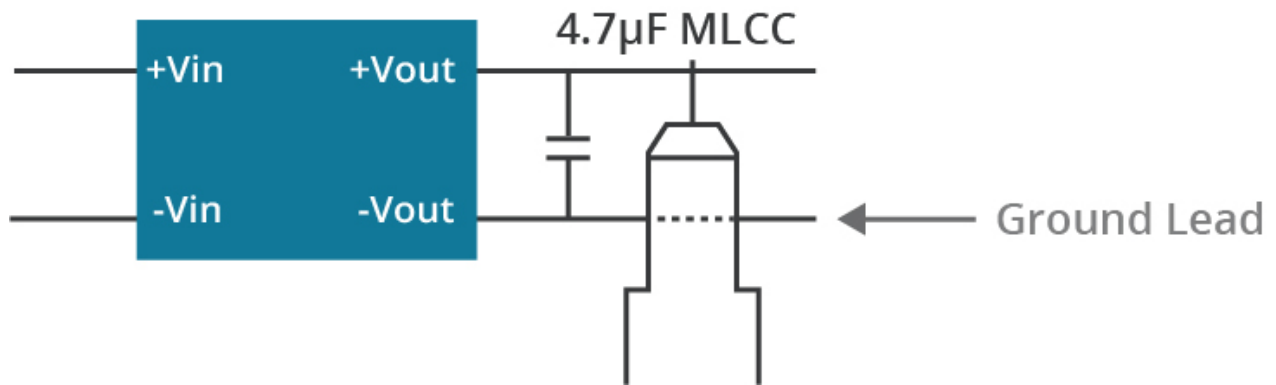

## REVISION HISTORY

---

| rev. | description     | date       |
|------|-----------------|------------|
| 1.0  | initial release | 09/07/2023 |

The revision history provided is for informational purposes only and is believed to be accurate.



# CUI INC

a bel group

**Headquarters**

20050 SW 112th Ave.  
Tualatin, OR 97062  
**800.275.4899**

Fax 503.612.2383  
**cui.com**  
techsupport@cui.com

CUI offers a two (2) year limited warranty. Complete warranty information is listed on our website.

CUI reserves the right to make changes to the product at any time without notice. Information provided by CUI is believed to be accurate and reliable. However, no responsibility is assumed by CUI for its use, nor for any infringements of patents or other rights of third parties which may result from its use.

CUI products are not authorized or warranted for use as critical components in equipment that requires an extremely high level of reliability. A critical component is any component of a life support device or system whose failure to perform can be reasonably expected to cause the failure of the life support device or system, or to affect its safety or effectiveness.