

SERIES: PQDE6W-Q110 | **DESCRIPTION:** DC-DC CONVERTER

FEATURES

- up to 6W isolated output
- industry standard pinout
- ultra-wide 4:1 input range (40~160)
- single/dual outputs
- 2250 Vdc isolation
- output short circuit, over current and over voltage protection
- input undervoltage protection
- wide operating temp: -40°C to +85°C
- EN62368 approved
- meets EN50155 railway standard



MODEL	input voltage		output voltage	output current		output power	ripple & noise ¹	efficiency ²
	typ (Vdc)	range (Vdc)	(Vdc)	min (mA)	max (mA)	max (W)	max (mVp-p)	min/typ (%)
PQDE6W-Q110-D5	110	40~160	±5	0	±600	6	100	78/80
PQDE6W-Q110-D12	110	40~160	±12	0	±250	6	100	82/84
PQDE6W-Q110-D15	110	40~160	±15	0	±200	6	100	83/85
PQDE6W-Q110-S5	110	40~160	5	0	1200	6	100	78/80
PQDE6W-Q110-S12	110	40~160	12	0	500	6	100	82/84
PQDE6W-Q110-S15	110	40~160	15	0	400	6	100	83/85
PQDE6W-Q110-S24	110	40~160	24	0	250	6	100	84/86

Notes: 1. From 5~100% load, nominal input, 20 MHz bandwidth oscilloscope, with 10 µF tantalum and 1 µF ceramic capacitors on the output. From 0~5% load, ripple and noise is <5% Vo
2. Measured at nominal input voltage and rated output load.

PART NUMBER KEY

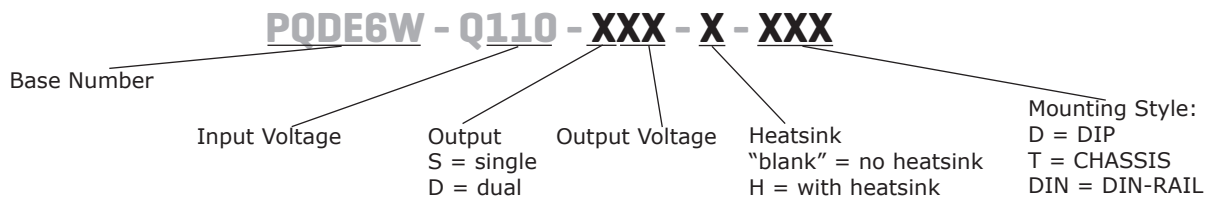

INPUT

parameter	conditions/description	min	typ	max	units
operating input voltage		40		170	Vdc
start-up voltage				40	Vdc
surge voltage	for maximum of 1 second	-0.7		180	Vdc
current	full load / no load		68/3	70/8	mA
filter	Pi filter				
CTRL	module on: CTRL open or pulled high (3.5~12 V) module off: CTRL pulled low to GND (0~1.2 V)				

OUTPUT

parameter	conditions/description	min	typ	max	units
maximum capacitive load	output voltage				
	5 Vdc dual output			470	μ F
	12 Vdc dual output			100	μ F
	15 Vdc dual output			100	μ F
	5 Vdc single output			1000	μ F
	12 Vdc single output			470	μ F
	15 Vdc single output			220	μ F
	24 Vdc single output			100	μ F
voltage accuracy	0%~100% load		± 1	± 3	%
line regulation	from low line to high line, full load				
	+Vo		± 0.2	± 0.5	%
	-Vo		± 0.5	± 1	%
load regulation	5%~100% load				
	+Vo		± 0.5	± 1	%
	-Vo		± 0.5	± 1.5	%
switching frequency	PWM mode		300		kHz
transient recovery time	25% load step change, nominal input voltage		300	500	μ s
transient response deviation	25% load step change, nominal input voltage				
	5 Vdc, ± 5 Vdc output		± 3	± 8	%
	other outputs		± 3	± 5	%
temperature coefficient	at full load		± 0.02	± 0.03	%/ $^{\circ}$ C

PROTECTIONS

parameter	conditions/description	min	typ	max	units
over voltage protection		110		160	%Vo
over current protection		120		210	%
short circuit protection	continuous, auto recovery				

SAFETY AND COMPLIANCE

parameter	conditions/description	min	typ	max	units
isolation voltage	input to output input/output to case	2,250 1,600			Vdc Vdc
isolation resistance	input to output at 500 Vdc	1,000			MΩ
isolation capacitance	input to output, 100 kHz / 0.1 V		1,000		pF
safety approvals	EN/IEC 62368				
EMI/EMC	CISPR 32/EN 55032 Class B				
conducted emissions	EN 50121-3-2 150kHz-500kHz 99dBuV, 500kHz-30MHz 93dBuV (see Fig.3 or Fig.4 for recommended circuit)				
radiated emissions	EN 50121-3-2 30MHz-230MHz 40dBuV/m at 10m, 230MHz-1GHz 47dBuV/m at 10m (see Fig.3 or Fig.4 for recommended circuit)				
ESD	IEC/EN 61000-4-2 Contact ±6KV/Air ±8KV, EN 50121-3-2 Contact ±6KV/Air ±8KV, perf. Criteria B				
radiated immunity	IEC/EN 61000-4-3 20 V/m, EN50121-3-2 20 V/m, perf. Criteria A				
EFT/burst	IEC/EN 61000-4-4 ±4KV, EN 50121-3-2 ±2kV 5/50ns 5kHz, perf. Criteria B				
surge	IEC/EN 61000-4-5 line to line ±2KV/line to ground ±4KV, EN 50121-3-2 line to line ±1KV (42Ω, 0.5μF) line to ground ±2KV (42Ω, 0.5μF), perf. Criteria B (see Fig.3 for recommended circuit)				
conducted immunity	IEC/EN 61000-4-6 10 Vr.m.s, EN50121-3-2 0.15MHz-80MHz 10Vr.m.s, perf. Criteria B				
MTBF	as per MIL-HDBK-217F, 25°C	1,000			K hours
RoHS	yes				

ENVIRONMENTAL

parameter	conditions/description	min	typ	max	units
operating temperature	see derating curve	-40		80	°C
storage temperature		-55		125	°C
storage humidity	non-condensing	5		95	%
vibration	IEC61373 - Category 1, Grade B				

MECHANICAL

parameter	conditions/description	min	typ	max	units
dimensions	25.40 × 25.40 × 11.70	Horizontal package (without heat sink)			mm
	25.40 × 25.40 × 16.20	Horizontal package (with heat sink)			mm
	76.00 × 31.50 × 21.20	A2S wiring package (without heat sink)			mm
	76.00 × 31.50 × 25.20	A2S wiring package (with heat sink)			mm
	76.00 × 31.50 × 25.80	A4S rail package (without heat sink)			mm
	76.00 × 31.50 × 29.80	A4S rail package (with heat sink)			mm
case material	aluminum alloy				
weight	Horizontal package without heatsink		12.5		g
	A2S wiring package without heatsink		36.0		g
	A4S rail package without heatsink		56.0		g
	Horizontal package with heatsink		17.0		g
	A2S wiring package with heatsink		40.0		g
	A4S rail package with heatsink		59.0		g

MECHANICAL DRAWING

units: mm [inch]

tolerance: ±0.50[±0.020]

pin diameter tolerance: ±0.10[±0.004]

PIN	PIN Out	
	Single	Dual
1	no pin	ctrl
2	GND	GND
3	Vin	Vin
4	+Vo	+Vo
5	no pin	0V
6	0V	-Vo

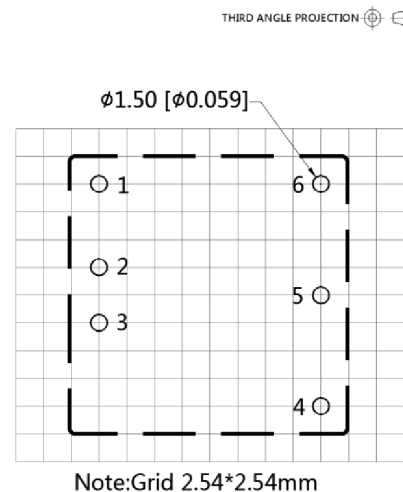
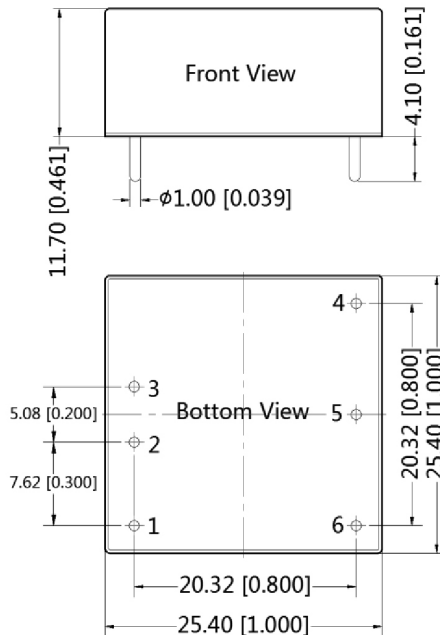

units: mm [inch]
 wire range: 24-12 AWG
 tightening torque: max 0.4 N·m
 tolerance: ±1.00 [±0.039]

PIN Out						
PIN	1	2	3	4	5	6
Single	NC	GND	Vin	+Vo	NC	0V
Dual	ctrl	GND	Vin	+Vo	0V	-Vo

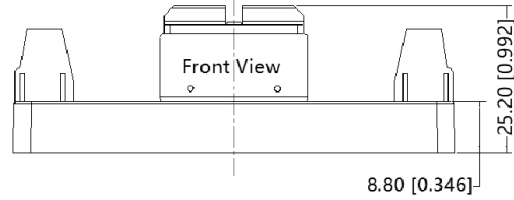
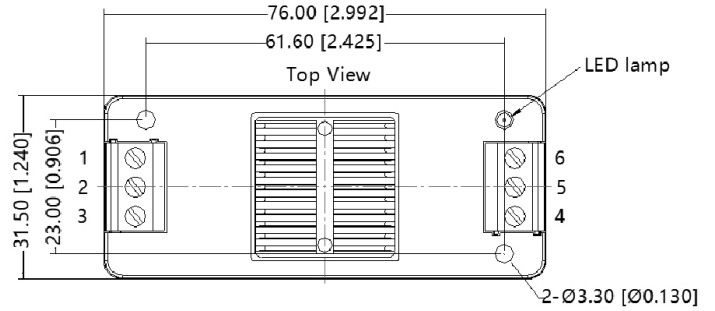

units: mm [inch]
 mounting rail: TS35
 wire range: 24-12 AWG
 tightening torque: max 0.4 N·m
 tolerance: ±1.00 [±0.039]

PIN Out						
PIN	1	2	3	4	5	6
Single	NC	GND	Vin	+Vo	NC	0V
Dual	ctrl	GND	Vin	+Vo	0V	-Vo

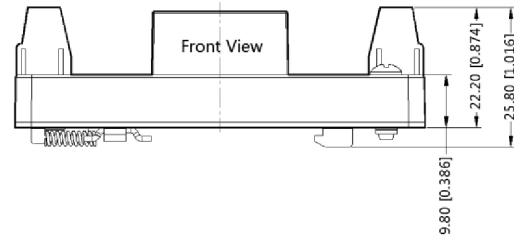
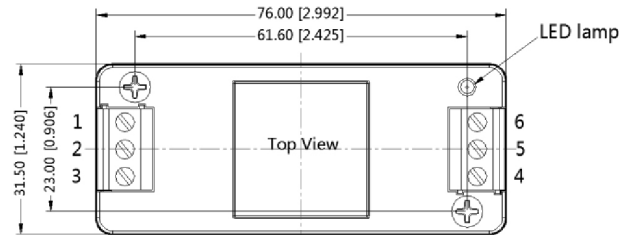

units: mm [inch]
 mounting rail: TS35
 wire range: 24-12 AWG
 tightening torque: max 0.4 N·m
 tolerance: ±1.00 [±0.039]

PIN Out						
PIN	1	2	3	4	5	6
Single	NC	GND	Vin	+Vo	NC	0V
Dual	ctrl	GND	Vin	+Vo	0V	-Vo

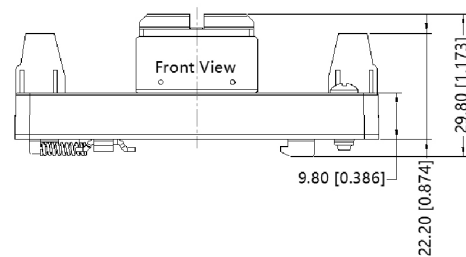
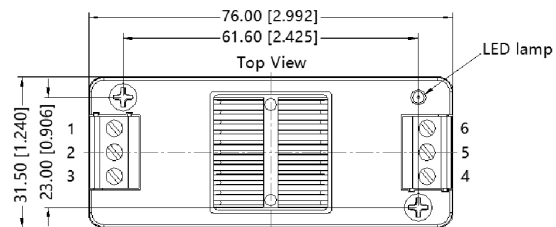

DERATING CURVE

Figure 1

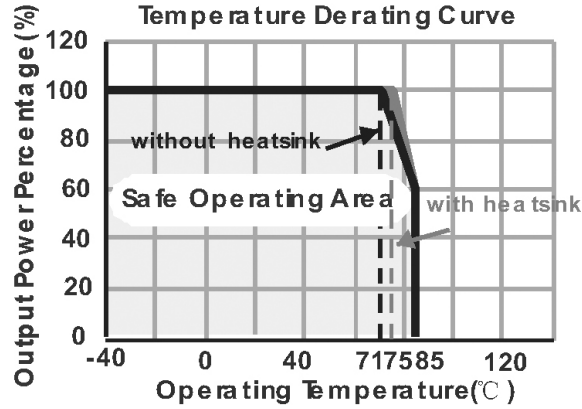

EFFICIENCY CURVES

Efficiency Vs Input Voltage (Full Load)

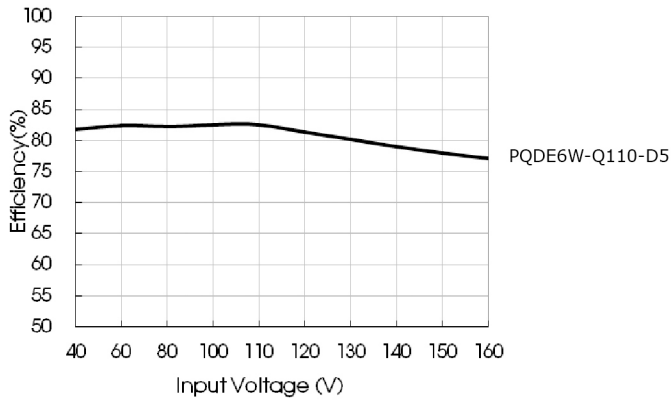

Efficiency Vs Output Load (Vin=110V)

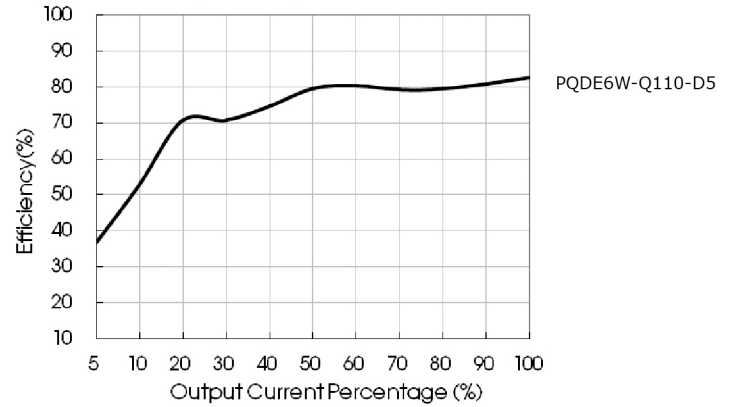

Efficiency Vs Input Voltage (Full Load)

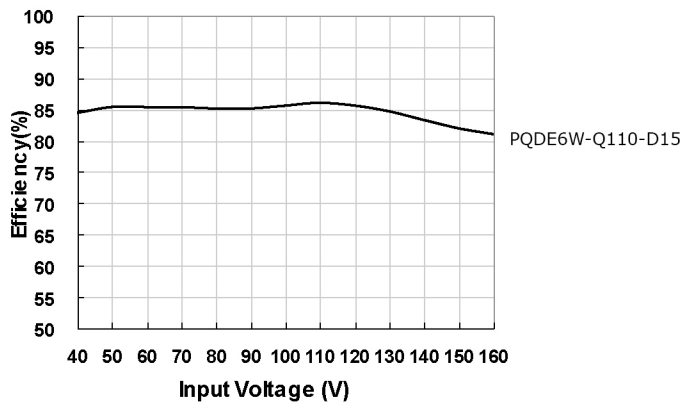

Efficiency Vs Output Load (Vin=110V)

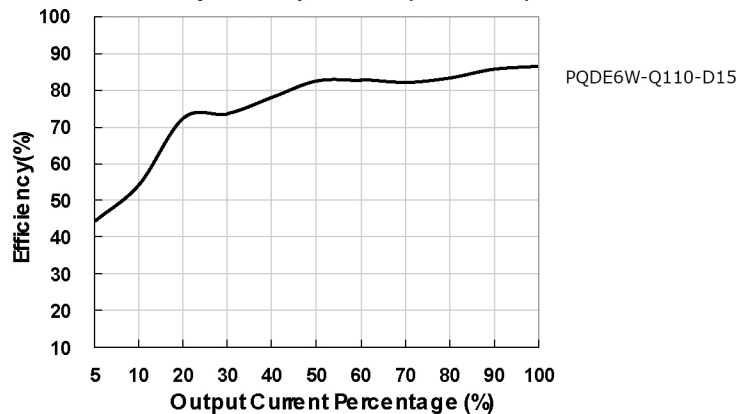

APPLICATION CIRCUIT

Figure 2

Dual Output

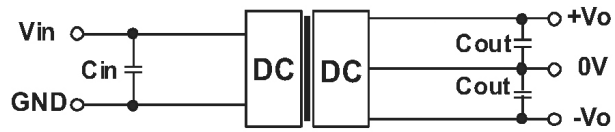

Single Output

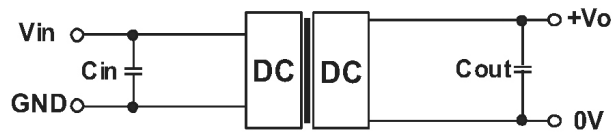

Cin	Cout
10 μ F -47 μ F	10 μ F

EMC RECOMMENDED CIRCUIT

Figure 3

Parameter description

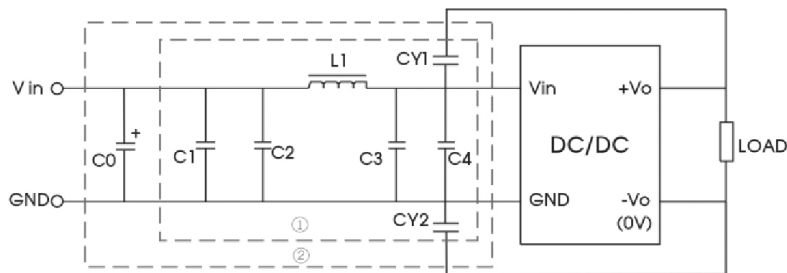

C0	100 μ F/200V
C1, C2, C3, C4	0.22 μ F/250V
L1	68 μ H
CY1, CY2	1nF/3KV

REVISION HISTORY

rev.	description	date
1.0	initial release	08/11/2020

The revision history provided is for informational purposes only and is believed to be accurate.



Headquarters
20050 SW 112th Ave.
Tualatin, OR 97062
800.275.4899

Fax 503.612.2383
cui.com
techsupport@cui.com

CUI offers a two (2) year limited warranty. Complete warranty information is listed on our website.

CUI reserves the right to make changes to the product at any time without notice. Information provided by CUI is believed to be accurate and reliable. However, no responsibility is assumed by CUI for its use, nor for any infringements of patents or other rights of third parties which may result from its use.

CUI products are not authorized or warranted for use as critical components in equipment that requires an extremely high level of reliability. A critical component is any component of a life support device or system whose failure to perform can be reasonably expected to cause the failure of the life support device or system, or to affect its safety or effectiveness.