

SERIES: PSK-25W | **DESCRIPTION:** INTERNAL AC-DC POWER SUPPLY

FEATURES

- wide input range (85~305 Vac)
- UL/EN/IEC 62368 certified
- meets CISPR32/EN 55032 Class B without external components
- short-circuit, over-current, over-voltage protections



MODEL	output voltage	output current max	output power max	ripple and noise typ	efficiency typ
	(Vdc)	(A)	(W)	(mVp-p)	(%)
PSK-25W-3 ^{1,2,3}	3.3	4.1	13.5	100	75
PSK-25W-5 ^{1,2,3}	5	4.1	20.5	100	78
PSK-25W-9 ^{1,2,3}	9	2.5	22.5	100	80
PSK-25W-12 ^{1,2,3}	12	2.1	25.0	100	82
PSK-25W-15 ^{1,2,3}	15	1.6	24.0	100	83
PSK-25W-24 ^{1,3}	24	1.1	26.4	100	85
PSK-25W-48 ^{1,2,3}	48	0.5	24.0	100	87

Notes: 1. Discontinued model - board mount version.
 2. Discontinued model - chassis mount version.
 3. Discontinued model - DIN-rail mount version.

PART NUMBER KEY

PSK - 25W - XX - X

Base Number

Output Voltage

Mounting Style

blank = board mount
 T = chassis mount
 DIN = DIN-rail mount

INPUT

parameter	conditions/description	min	typ	max	units
voltage		85		305	Vac
		100		430	Vdc
frequency		47		63	Hz
current	at 155 Vac			0.6	A
	at 230 Vac			0.34	A
inrush current	at 155 Vac		20		A
	at 230 Vac		40		A
no load power consumption	at 230 Vac			0.5	W

OUTPUT

parameter	conditions/description	min	typ	max	units
capacitive load	3.3 Vdc output models			48,000	μF
	5 Vdc output models			12,240	μF
	9 Vdc output models			5,600	μF
	12 Vdc output models			5,400	μF
	15 Vdc output models			2,400	μF
	24 Vdc output models			1,440	μF
output voltage accuracy	3.3 V output models		±3		%
	all other voltages		±2		%
line regulation			±0.5		%
load regulation			±1.0		%
hold-up time	at 115 Vac		10		ms
	at 230 Vac		60		ms
trimmability	see application circuit		±10		%
switching frequency			65		kHz
temperature coefficient			±0.02		%/°C

PROTECTIONS

parameter	conditions/description	min	typ	max	units
over voltage protection	3.3 / 5 Vdc output models			7.5	V
	9 Vdc output models			15	V
	12 / 15 Vdc output models			20	V
	24 Vdc output models			30	V
	48 Vdc output models			60	V
over current protection	auto recovery	120		300	I _o %
short circuit protection	hiccup, continuous, auto recovery				

SAFETY & COMPLIANCE

parameter	conditions/description	min	typ	max	units
isolation voltage	input to output input to earth	4,000 2,500			Vac Vac
safety approvals	IEC 62368/EN 62368/UL 62368				
safety class	Class II				
EMI/EMC	CISPR32/EN 55032: 2015 Class B				
ESD	IEC/EN 61000-4-2, Contact $\pm 6\text{KV}$ / Air $\pm 8\text{KV}$, perf. Criteria B				
radiated immunity	EC/EN 61000-4-3, 10V/m, perf. Criteria A				
EFT/burst	IEC/EN 61000-4-4, $\pm 2\text{KV}$, perf. Criteria B IEC/EN 61000-4-4, $\pm 4\text{KV}$, perf. Criteria B				
surge	IEC/EN 61000-4-5, line to line $\pm 1\text{KV}$, line to ground $\pm 2\text{KV}$, perf. Criteria B				
conducted immunity	EC/EN 61000-4-6, 10Vr.m.s, perf. Criteria A				
MTBF	as per MIL-HDBK-217F at 25°C	300,000			hours
RoHS	yes				

DERATING CURVE

TEMPERATURE DERATING CURVE

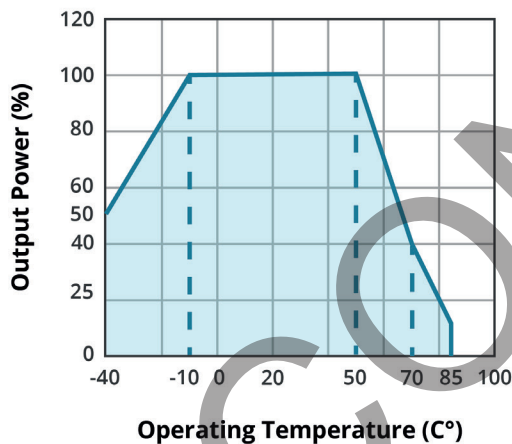

INPUT VOLTAGE DERATING CURVE (25°C)

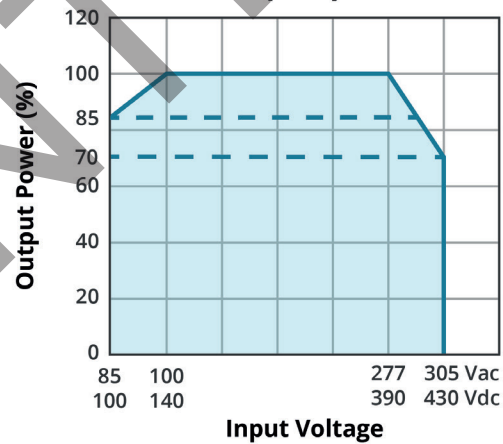

EFFICIENCY CURVES

EFFICIENCY VS INPUT VOLTAGE (Full load)

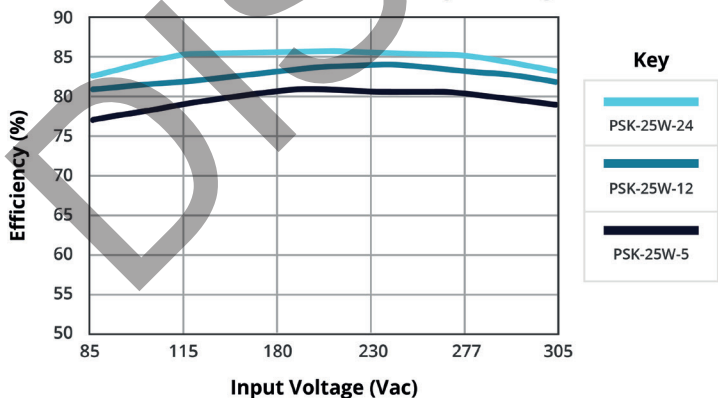

EFFICIENCY VS OUTPUT LOAD (Vin = 230 Vac)

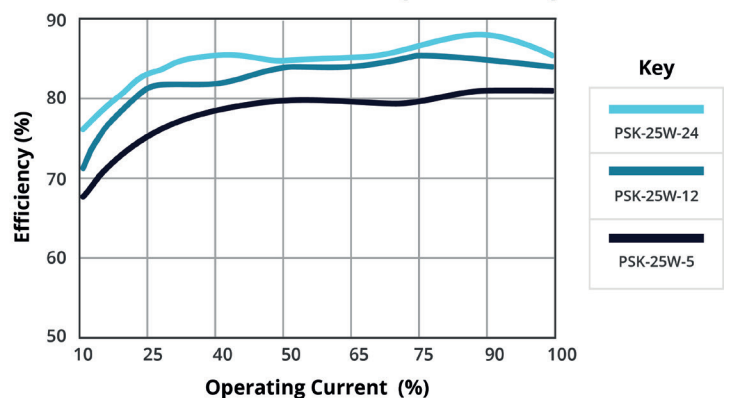

ENVIRONMENTAL

parameter	conditions/description	min	typ	max	units
operating temperature		-40		85	°C
storage temperature		-40		85	°C
storage humidity	non-condensing	0		95	%

SOLDERABILITY

parameter	conditions/description	min	typ	max	units
wave soldering	for 5~10 seconds	255	260	265	°C
hand soldering	for 3~5 seconds	350	360	370	°C

MECHANICAL

parameter	conditions/description	min	typ	max	units
dimensions	70.00 x 48.00 x 23.50 (board mount)				mm
	96.10 x 54.00 x 32.00 (chassis mount)				mm
	96.10 x 54.00 x 36.60 (DIN-rail)				mm
weight	board mount		120		g
	chassis mount		170		g
	DIN-rail		210		g
cooling	natural convection				
case material	Black plastic, flame-retardant and heat-resistant (UL94V-0)				

MECHANICAL DRAWING (BOARD MOUNT)

units: mm [inch]

tolerance: ± 0.50 [± 0.020]pin diameter tolerances: ± 0.10 [± 0.004]

PIN CONNECTIONS	
PIN	Function
1	\oplus
2	AC (N)
3	AC (L)
4	+Vo
5	-Vo
6	Trim

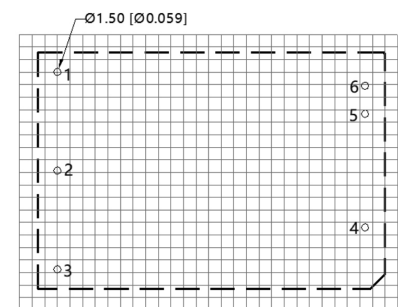
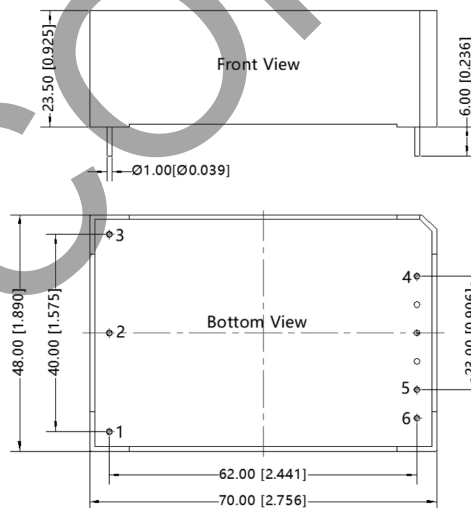

Note: Grid 2.54*2.54mm

MECHANICAL DRAWING [CHASSIS MOUNT]

units: mm [inch]
 tolerance: ± 1.00 [± 0.039]
 wire range: 24~12 AWG
 tightening torque: max 0.4 N·m

PIN CONNECTIONS	
PIN	Function
1	\oplus
2	AC (N)
3	AC (L)
4	+Vo
5	NC
6	Trim
7	NC
8	-Vo

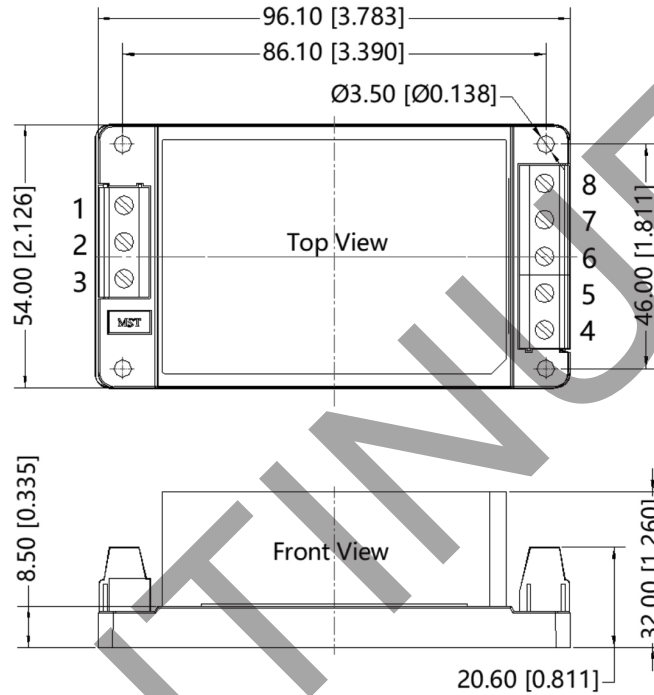

MECHANICAL DRAWING [DIN-RAIL MOUNT]

units: mm [inch]
 tolerance: ± 1.00 [± 0.039]
 wire range: 24~12 AWG
 tightening torque: max 0.4 N·m

PIN CONNECTIONS	
PIN	Function
1	\oplus
2	AC (N)
3	AC (L)
4	+Vo
5	NC
6	Trim
7	NC
8	-Vo

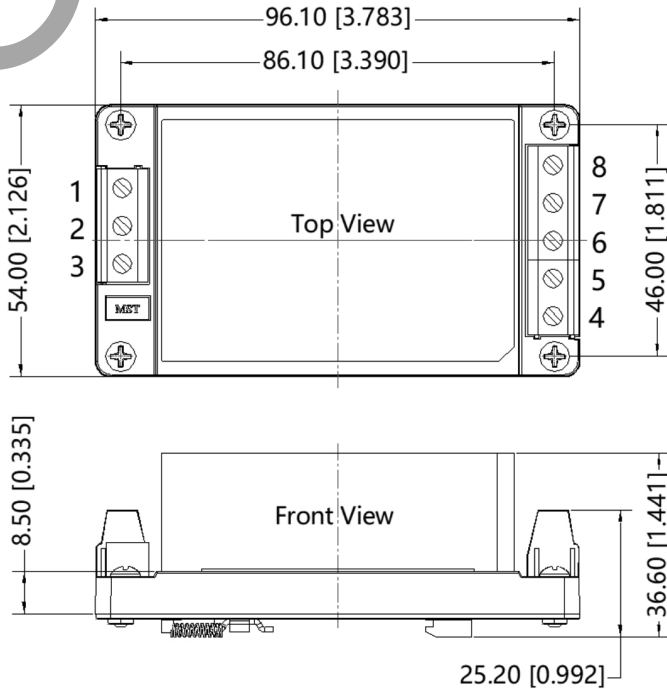

APPLICATION CIRCUIT

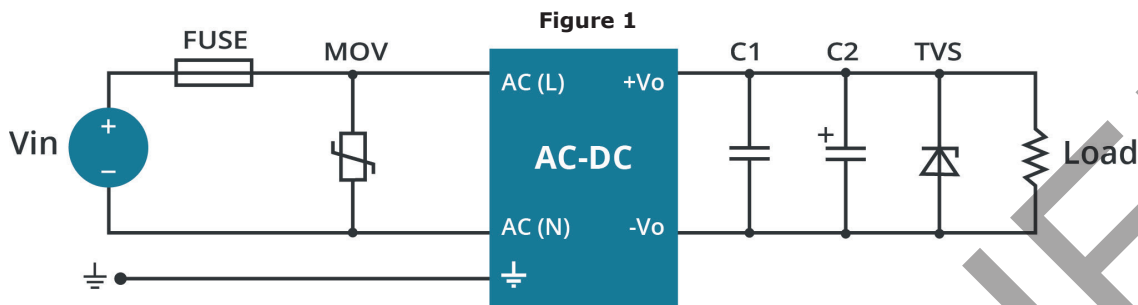

Table 1

Recommended External Circuit Components					
Vo (Vdc)	FUSE ⁶	MOV ⁶	C1	C2	TVS
3.3	3.15A/300V slow-blow, required	S14K350	1 μ F	330 μ F	SMBJ7.0A
5				330 μ F	SMBJ7.0A
9				330 μ F	SMBJ12A
12				330 μ F	SMBJ20A
15				330 μ F	SMBJ20A
24				120 μ F	SMBJ30A
48				68 μ F	SMBJ64A

Notes: 6. Chassis Mount and DIN-Rail Mount versions include the fuse and MOV components.

EMC RECOMMENDED CIRCUIT

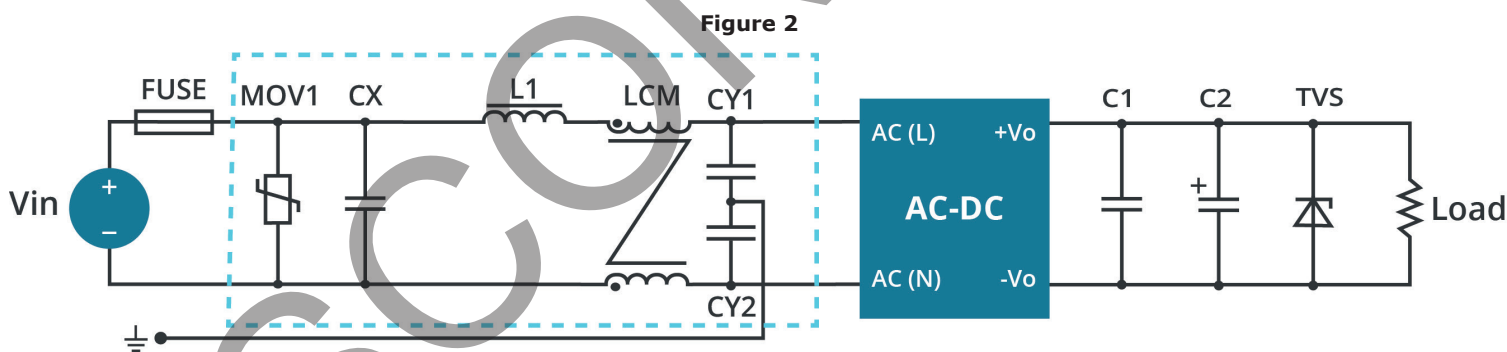

Table 2

Recommended External Circuit Components	
MOV	S14K350
CY1/CY2	1000 pF/400 Vac
CX	0.1 μ F/310 Vac
LCM	10 mH
L1	4.7 μ H/ 2 A
FC-LX1D	2 KV/4 KV EMC filter
FUSE	3.15 A/300 V, slow blow, required

Note: Also refer to Table 1.

- Notes:
- C1 is a ceramic capacitor used to filter high frequency noise.
 - C2 is an electrolytic capacitor and it is recommended to be high frequency and low impedance. For capacitance and current of capacitor, refer to the datasheet provided by the manufacturer. Voltage derating of capacitor should be at least 80%.
 - TVS is a recommended component to protect post-circuits (if converter fails).

TRIM FUNCTION

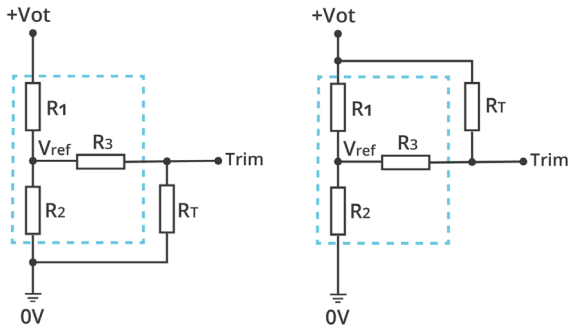

Trim up

Trim down

Note: Trim resistor connection (dashed line shows internal resistor network)

$$R_{trim - up} = \frac{a R_2}{R_2 - a} - R_3$$

$$a = \frac{V_{ref}}{V_{ot} - V_{ref}} \times R_1$$

$$R_{trim - down} = \frac{a R_1}{R_1 - a} - R_3$$

$$a = \frac{V_{ot} - V_{ref}}{V_{ref}} \times R_2$$

RT = Trim Resistor Value
a = Self-defined parameter

Table 3

Vout	R1(KΩ)	R2 (KΩ)	R3 (KΩ)	Vref(V)	Vot(V)
3.3	2	1.19	1	1.24	Output voltage after regulation, variation ≤ ±10%
5	3.3	3.3	1	2.5	
9	7.5	2.87	1	2.5	
12	3.83	1	1	2.5	
15	7.5	1.5	1	2.5	
24	8.66	1	1	2.5	
48	27	1.49	1	2.5	

REVISION HISTORY

rev.	description	date
1.0	initial release	06/30/2020
1.01	curves and circuit drawings updated	03/25/2021
1.02	efficiency curves updated	11/04/2021
1.03	UKCA mark added	06/03/2022
1.04	discontinued models PSK-25-3, PSK-25-3-T, PSK-25-3-DIN, PSK-25-95, PSK-25-5-T, PSK-25-5-DIN, PSK-25-9, PSK-25-9-T, PSK-25-9-DIN, PSK-25-12, PSK-25-12-T, PSK-25-12-DIN, PSK-25-15, PSK-25-15-T, PSK-25-15-DIN, PSK-25-24, PSK-25-24-DIN, PSK-25-48, PSK-25-48-T, PSK-25-48-DIN	09/13/2022

The revision history provided is for informational purposes only and is believed to be accurate.



Headquarters
20050 SW 112th Ave.
Tualatin, OR 97062
800.275.4899

Fax 503.612.2383
cui.com
techsupport@cui.com

CUI offers a two (2) year limited warranty. Complete warranty information is listed on our website.

CUI reserves the right to make changes to the product at any time without notice. Information provided by CUI is believed to be accurate and reliable. However, no responsibility is assumed by CUI for its use, nor for any infringements of patents or other rights of third parties which may result from its use.

CUI products are not authorized or warranted for use as critical components in equipment that requires an extremely high level of reliability. A critical component is any component of a life support device or system whose failure to perform can be reasonably expected to cause the failure of the life support device or system, or to affect its safety or effectiveness.