

SERIES: PSK-36E | **DESCRIPTION:** INTERNAL AC-DC POWER SUPPLY

FEATURES

- universal input range (90 ~ 264 Vac)
- Class B emissions (EN 55032/CISPR)
- certified to IEC/EN/UL 62368-1
- designed to meet IEC/EN 60335
- short circuit, over voltage protection
- <0.1 W no-load power consumption
- Class II, Class I (determined at end use)
- 5,000 m operating altitude



MODEL	output voltage	output current	output power	ripple and noise ¹	efficiency ²
	typ (Vdc)	max (A)	max (W)	max (mVp-p)	typ (%)
PSK-36E-5	5	6.0	30	100	85
PSK-36E-12	12	3.0	36	120	88
PSK-36E-15	15	2.4	36	150	88
PSK-36E-24	24	1.5	36	240	89
PSK-36E-48	48	0.75	36	480	89

Notes: 1. At full load, nominal input, 20 MHz bandwidth oscilloscope with 0.1µF ceramic capacitor and 10 µF electrolytic capacitor.
 2. At 230 Vac input.
 3. All specifications are measured at Ta=25°C, humidity <75%, nominal input voltage, and rated output load unless otherwise specified.

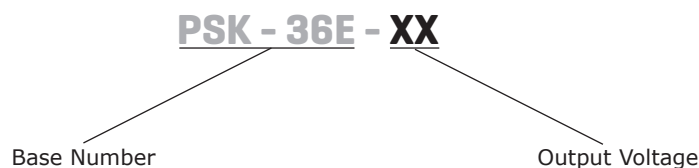
PART NUMBER KEY

INPUT

parameter	conditions/description	min	typ	max	units
voltage ⁴	ac input (safety approved)	90	100~240	264	Vac
	dc input	120		370	Vdc
frequency		47	50~60	63	Hz
current	at 100 Vac, full load			0.9	A
inrush current	at 240 Vac, full load			90	A
leakage current				0.25	mA
no load power consumption				0.1	W

Notes: 4. See the derating curves for more details.

OUTPUT

parameter	conditions/description	min	typ	max	units
capacitive load	5 Vdc output model			6,000	μF
	12 Vdc output model			3,000	μF
	15 Vdc output model			2,400	μF
	24 Vdc output model			1,500	μF
	48 Vdc output model			750	μF
output voltage set point	5 Vdc output model	4.90		5.10	Vdc
	12 Vdc output model	11.76		12.24	Vdc
	15 Vdc output model	14.70		15.30	Vdc
	24 Vdc output model	23.52		24.48	Vdc
	48 Vdc output model	47.02		48.96	Vdc
voltage accuracy	5 Vdc output model		±2		%
	all other output models		±1		%
line regulation	high line to low line			±0.5	%
load regulation	10 % to 100 % load			±1.0	%
hold-up time	at 115 Vac		8		ms
switching frequency			65		kHz

PROTECTIONS

parameter	conditions/description	min	typ	max	units
over voltage protection	latch mode				
	5 Vdc output model			7.44	Vdc
	12 Vdc output model			16.8	Vdc
	15 Vdc output model			21.5	Vdc
	24 Vdc output model			31.5	Vdc
48 Vdc output model			63.0	Vdc	
over current protection	auto recovery, hiccup	110		180	%
short circuit protection	auto recovery				

SAFETY & COMPLIANCE

parameter	conditions/description	min	typ	max	units
isolation voltage	input to output, for 1 minunte			4,000	Vdc
safety approvals	certified to 62368-1: IEC, EN, UL designed to meet 60335-1: EN				
safety class	Class II, Class I (determined at end use)				
EMC	EN 55032:2015+A11:2020, EN 61204-3:2018, EN IEC 61000-6-3:2021, EN IEC 61000-6-4:2019, EN IEC 61000-3-2:2019, EN 61000-3-3:2013+A1:2019, Class B				
EMC immunity	EN 55035:2017+A11:2020, EN 61204-3:2018, EN IEC 61000-6-1:2019, EN IEC 61000-6-2:2019				
conducted emissions	EN 55032:2015+A11:2020, EN 61204-3:2018, EN IEC 61000-6-3:2021, EN IEC 61000-6-4:2019, Class B				
radiated emissions	EN 55032:2015+A11:2020, EN 61204-3:2018, EN IEC 61000-6-3:2021, EN IEC 61000-6-4:2019, Class B				
ESD	IEC 61000-4-2:2008, perf. Criteria A				

SAFETY & COMPLIANCE

parameter	conditions/description	min	typ	max	units
radiated immunity	IEC 61000-4-3:2020, perf. Criteria A				
EFT/burst	IEC 61000-4-4:2012, ±1 kV, ±2 kV, perf. Criteria A				
surge	IEC 61000-4-5:2014+A1:2017, L-N: ±0.5 kV, ±1 kV, L-E(Ground): ±0.5 kV, ±1 kV, ±2 kV, perf. Criteria A				
conducted immunity	IEC 61000-4-6:2013+COR1:2015, perf. Criteria A				
PFMF	IEC 61000-4-8:2009, perf. Criteria A				
voltage dips	IEC 61000-4-11:2020, Dip: 30% Reduction, Dip >95% Reduction, perf. Criteria A				
voltage interruption	IEC 61000-4-11:2020, >95% Reduction, perf. Criteria B				
MTBF	as per MIL-HDBK-217F at 25°C	700,000			hours
RoHS	yes				

ENVIRONMENTAL

parameter	conditions/description	min	typ	max	units
operating temperature	see derating curve (safety approved at maximum 50°C)	-40		80	°C
storage temperature		-40		85	°C
storage humidity	non-condensing	0		93	%
altitude	IEC/EN/UL 62368-1 OVC II designed to meet EN 60335-1 OVC II			5,000 2,000	m m

MECHANICAL

parameter	conditions/description	min	typ	max	units
dimensions	3.100 x 1.600 x 1.134 [78.8 x 40.7 x 28.80 mm]				inch
weight			156		g

DERATING CURVE

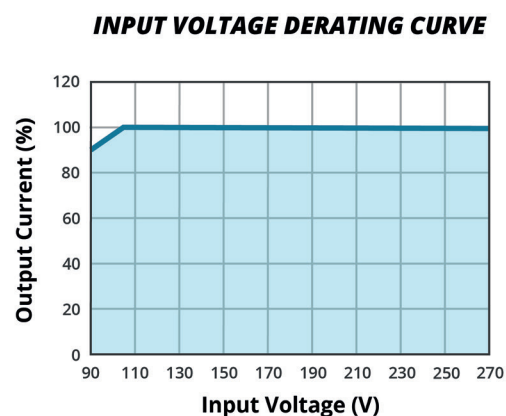
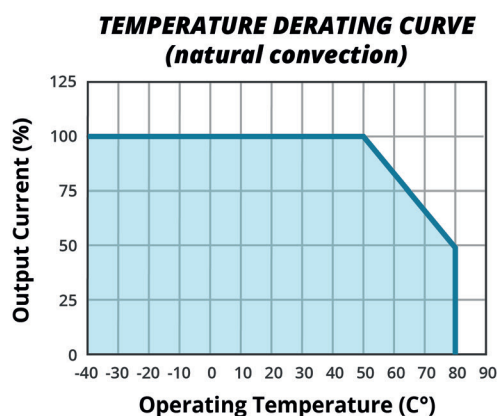

MECHANICAL DRAWING

units: inch [mm]

tolerance: inches: x.xx = ±0.03, x.xxx = ±0.020

mm: x.x - ±0.7, x.xx = ±0.50

PIN CONNECTIONS	
PIN	Function
1	AC(N)
2	AC(L)
3	+Vout
4	+Vout
5	-Vout
6	-Vout

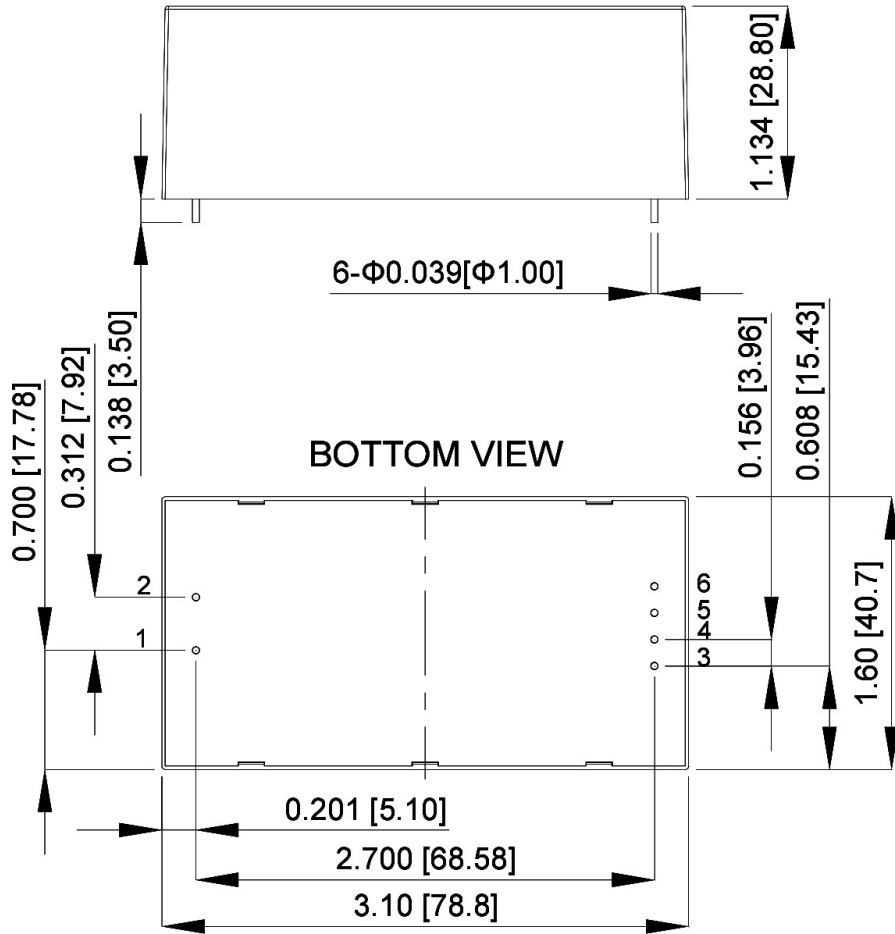

EFFICIENCY CURVES

**EFFICIENCY VS OUTPUT LOAD
(PSK-36E-5)**

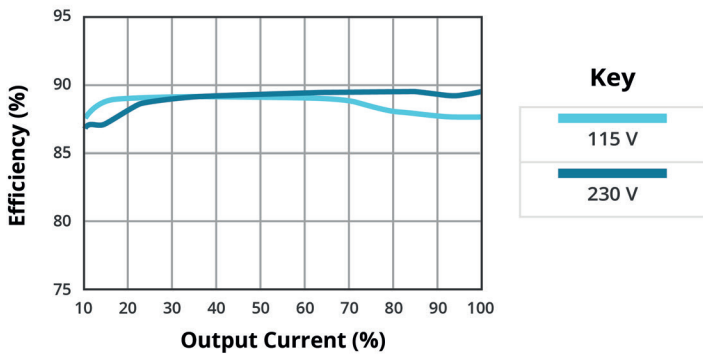

**EFFICIENCY VS OUTPUT LOAD
(PSK-36E-12)**

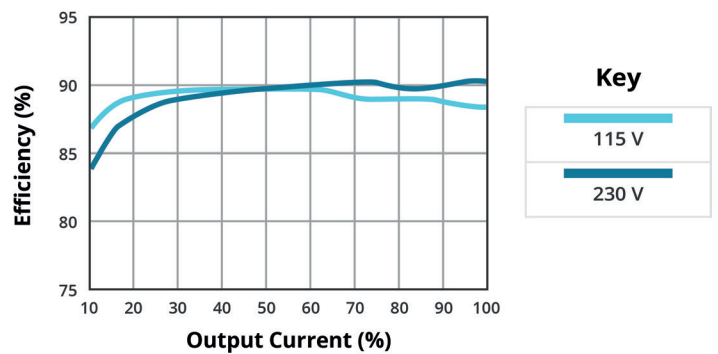

EFFICIENCY CURVES (CONTINUED)

**EFFICIENCY VS OUTPUT LOAD
(PSK-36E-15)**

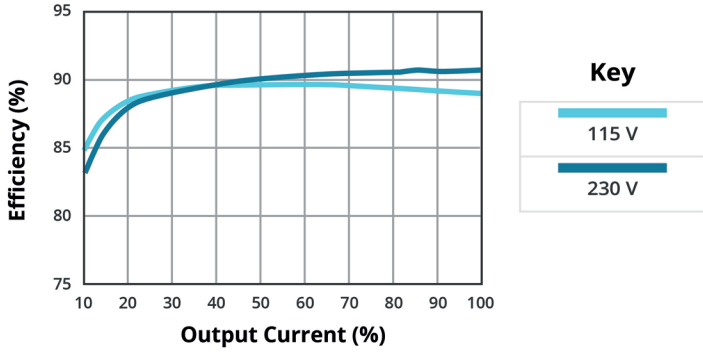

**EFFICIENCY VS OUTPUT LOAD
(PSK-36E-24)**

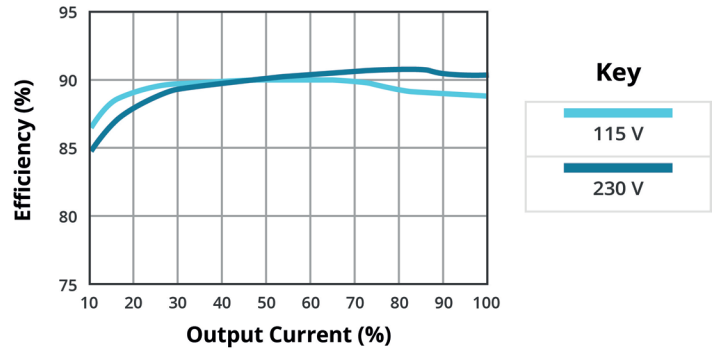

**EFFICIENCY VS OUTPUT LOAD
(PSK-36E-48)**

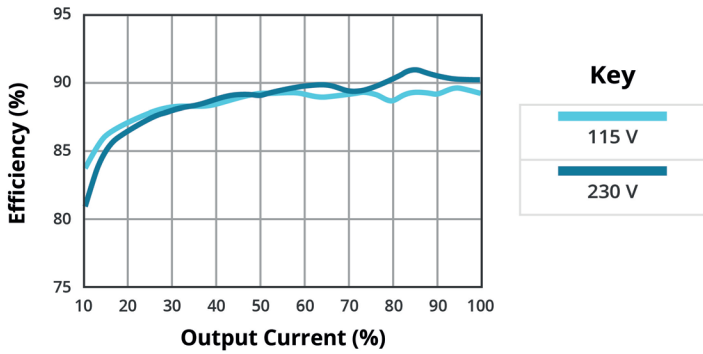

ELECTRICAL BLOCK DIAGRAM

Figure 1

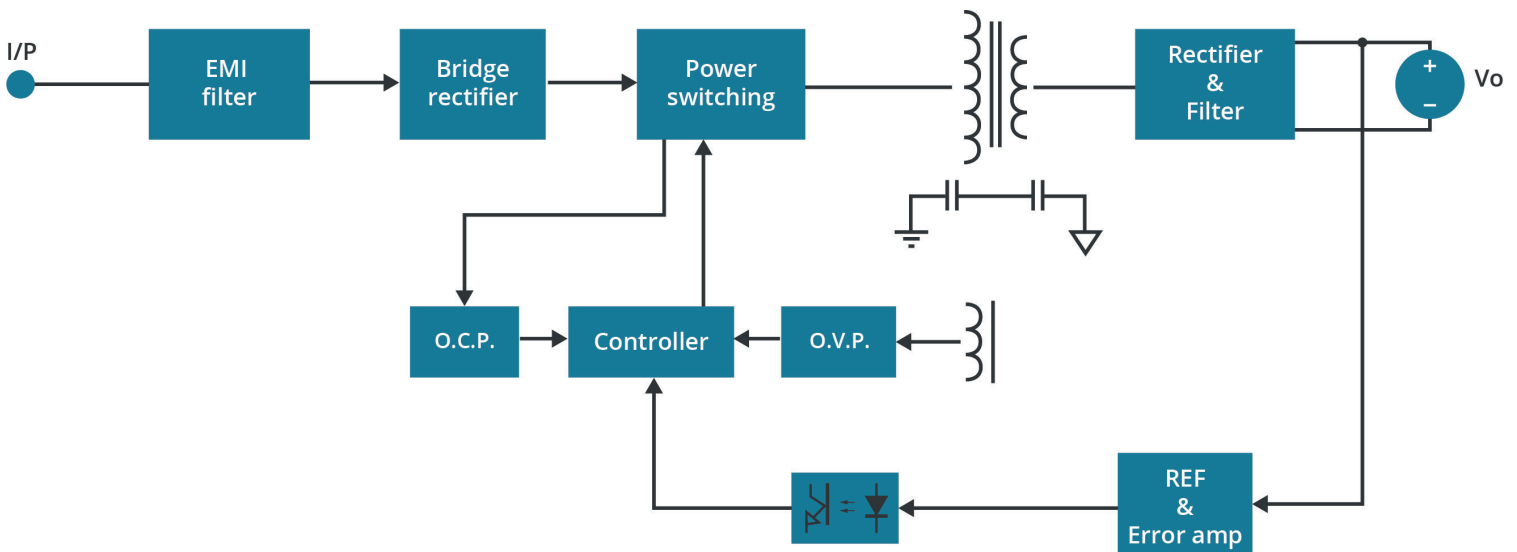

REVISION HISTORY

rev.	description	date
1.0	initial release	10/15/2024
1.01	safeties updated	12/20/2024

The revision history provided is for informational purposes only and is believed to be accurate.



Headquarters
15575 SW Sequoia Pkwy #100
Portland, OR 97224
800.275.4899

Fax 503.612.2383
cui.com
techsupport@cui.com

CUI offers a two (2) year limited warranty. Complete warranty information is listed on our website.

CUI reserves the right to make changes to the product at any time without notice. Information provided by CUI is believed to be accurate and reliable. However, no responsibility is assumed by CUI for its use, nor for any infringements of patents or other rights of third parties which may result from its use.

CUI products are not authorized or warranted for use as critical components in equipment that requires an extremely high level of reliability. A critical component is any component of a life support device or system whose failure to perform can be reasonably expected to cause the failure of the life support device or system, or to affect its safety or effectiveness.