



SERIES: PSK-S10C | **DESCRIPTION:** AC-DC POWER SUPPLY

FEATURES

- universal input (85~264 Vac)
- -40~70°C operating range
- over voltage/current protection
- 4,000 Vac input/output isolation voltage
- board/chassis/DIN-Rail configurations
- CISPR32/EN55032 Class B
- UL/EN/IEC 62368-1 and EN 60335-1 certified



MODEL	output voltage (Vdc)	output current		output power max (W)	ripple and noise ¹ max (mVp-p)	efficiency ² typ (%)
		min (mA)	max (mA)			
PSK-S10C-3	3.3	0	2000	6.6	100	71
PSK-S10C-5	5	0	2000	10	100	76
PSK-S10C-9	9	0	1100	10	100	80
PSK-S10C-12	12	0	900	10	100	81
PSK-S10C-15	15	0	700	10	100	81
PSK-S10C-24	24	0	450	10	100	83

Notes: 1. At full load, nominal input, 20 MHz bandwidth oscilloscope, with 1 μ F ceramic and 10 μ F electrolytic capacitors on the output.
 2. At 230 Vac input.
 3. All specifications are measured at T_a=25°C, humidity <75%, nominal input voltage, and rated output load unless otherwise specified.

PART NUMBER KEY

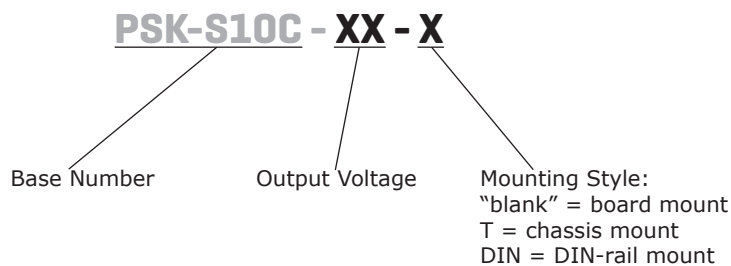

INPUT

parameter	conditions/description	min	typ	max	units
voltage		85		264	Vac
		100		370	Vdc
frequency		47		63	Hz
current	at 115 Vac			230	mA
	at 230 Vac			150	mA
inrush current	at 115 Vac		15		A
	at 230 Vac		30		A
no load power consumption				0.5	W

OUTPUT

parameter	conditions/description	min	typ	max	units
capacitive load	3.3 Vdc output models			26,400	μF
	5 Vdc output models			9,440	μF
	9 Vdc output models			3,600	μF
	12 Vdc output models			2,000	μF
	15 Vdc output models			1,170	μF
	24 Vdc output models			370	μF
initial set point accuracy	3.3 Vdc output models		±3		%
	all other models		±2		%
line regulation	at full load		±0.5		%
load regulation	from 0~100% load		±1		%
hold-up time	at 115 Vac, full load		15		ms
	at 230 Vac, full load		80		ms
switching frequency			100		kHz
temperature coefficient			±0.02		%/°C

PROTECTIONS

parameter	conditions/description	min	typ	max	units
over voltage protection	output voltage clamp				
	3.3, 5 Vdc output models			7.5	Vdc
	9 Vdc output models			15	Vdc
	12, 15 Vdc output models			20	Vdc
	24 Vdc output models			30	Vdc
over current protection	auto recovery	110		300	%
short circuit protection	hiccup, continuous, auto recovery				

SAFETY & COMPLIANCE

parameter	conditions/description	min	typ	max	units
isolation voltage	input to output for 1 minute, 5 mA	4,000			Vac
safety approvals	UL 62368-1, EN 62368-1, IEC 62368-1, EN 60335-1				
safety class	Class II				
conducted emissions	CISPR32/EN55032, Class B				
radiated emissions	CISPR32/EN55032, Class B				
ESD	IEC/EN61000-4-2, contact ±6 kV/ air ±8 kV, Class B				
radiated immunity	IEC/EN61000-4-3, 10 V/m, Class A				

SAFETY & COMPLIANCE (CONTINUED)

parameter	conditions/description	min	typ	max	units
EFT/burst	IEC/EN61000-4-4, ±2 kV, Class B				
	IEC/EN61000-4-4, ±4 kV, Class B (external circuit required, see Figure 2)				
surge	IEC/EN61000-4-5, line to line ±1 kV, Class B (external circuit required, see Figure 1)				
	IEC/EN61000-4-5, line to line ±2 kV/line to ground ±4 kV, Class B (external circuit required, see Figure 2)				
conducted immunity	IEC/EN61000-4-6, 10 Vrms, Class A				
voltage dips & interruptions	IEC/EN61000-4-11 Class B, 0%-70%				
MTBF	as per MIL-HDBK-217F at 25°C	300,000			hours
RoHS	yes				

Notes: 4. The power supply is considered a component which will be installed into final equipment. The final equipment still must be tested to meet the necessary EMC directives.

ENVIRONMENTAL

parameter	conditions/description	min	typ	max	units
operating temperature	see derating curves	-40		70	°C
storage temperature		-40		105	°C
storage humidity	non-condensing			95	%

SOLDERABILITY⁵

parameter	conditions/description	min	typ	max	units
hand soldering	for 3~5 seconds	350	360	370	°C
wave soldering	for 5~10 seconds	255	260	265	°C

Notes: 5. For board mount models only

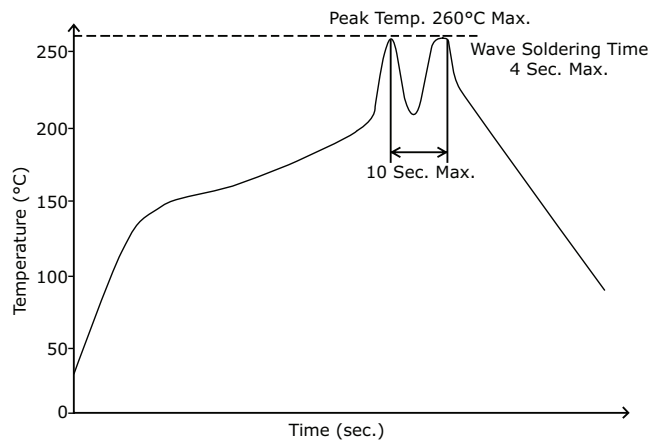

DERATING CURVES

Load vs. Ambient Temperature
(at 85~264 Vac / 100~370 Vdc Input Voltage)

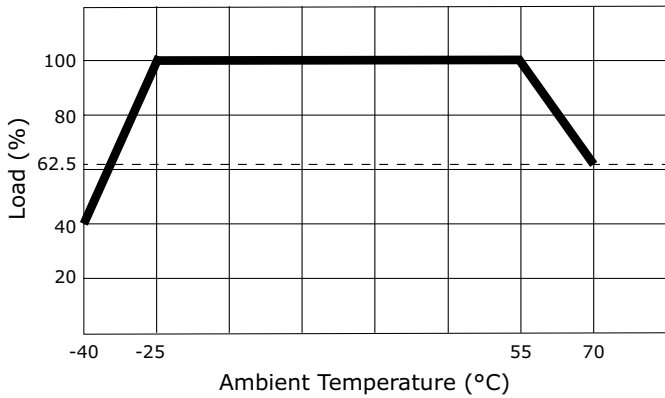

Load vs. Input Voltage
(at 25°C Ambient Temperature)

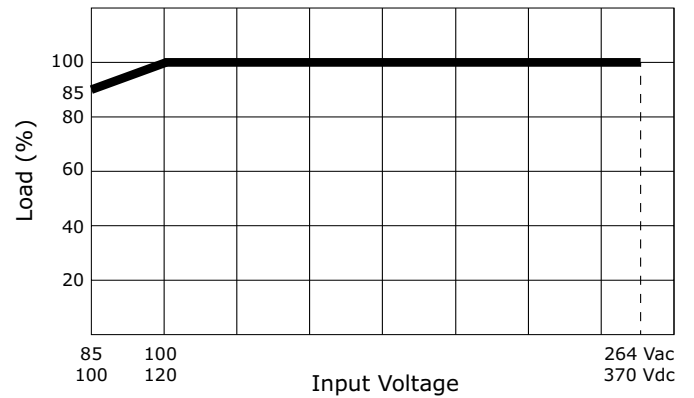

EFFICIENCY CURVES

Efficiency vs. Input Voltage
(at full load)

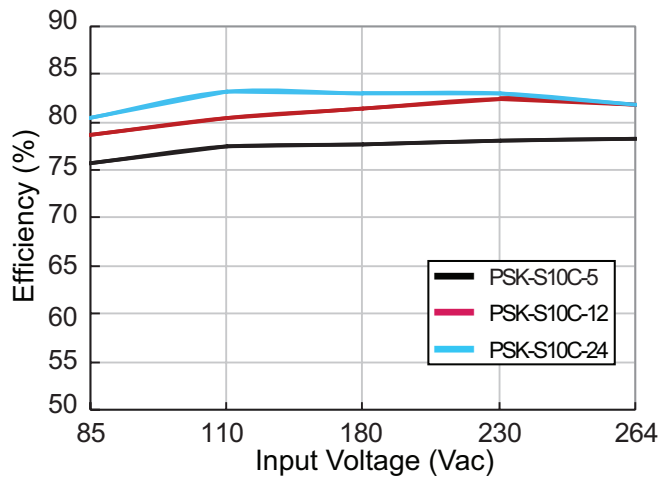

Efficiency vs. Load Current
(at 230 Vac)

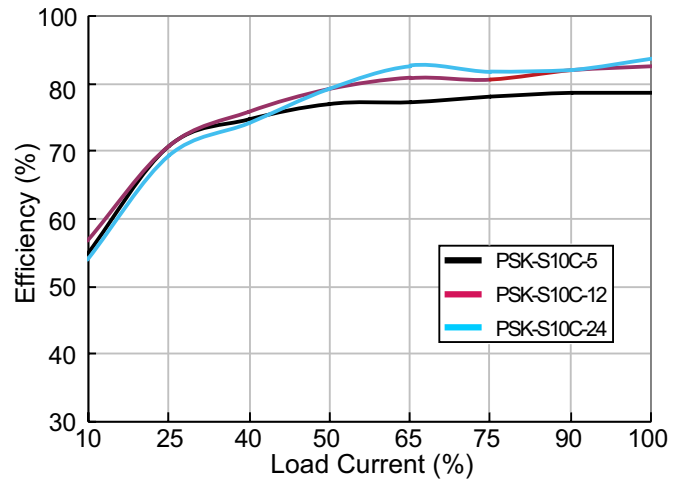

MECHANICAL

parameter	conditions/description	min	typ	max	units
dimensions	board mount: 53.80 x 28.80 x 19.00 (2.118 x 1.134 x 0.748 inch)				mm
	chassis mount: 76.00 x 31.50 x 27.80 (2.992 x 1.24 x 1.094 inch)				mm
	DIN-Rail mount: 76.00 x 31.50 x 32.40 (2.992 x 1.24 x 1.276 inch)				mm
case material	black flame-retardant and heat-resistant plastic (UL94V-0)				
weight	board mount		48		g
	chassis mount		68		g
	DIN-Rail mount		88		g

MECHANICAL DRAWING (BOARD MOUNT)

units: mm[inch]
 tolerance: $\pm 0.50[\pm 0.020]$
 pin diameter tolerance: $\pm 0.10[\pm 0.004]$

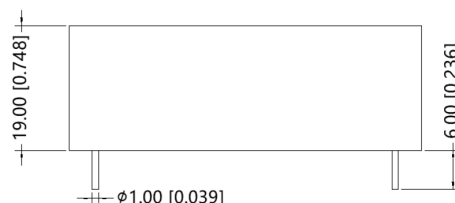

PIN CONNECTIONS	
PIN	Function
1	AC (N)
2	AC (L)
3	-Vo
4	+Vo

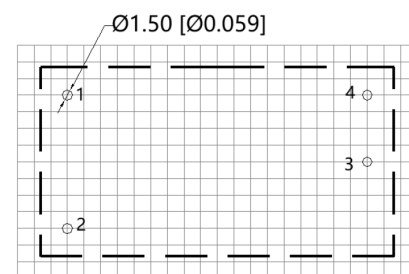
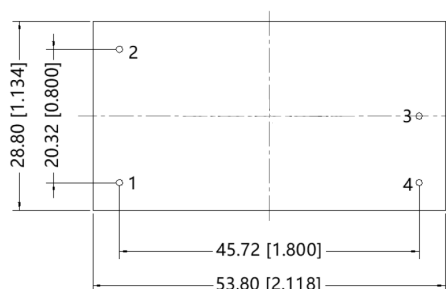

Note : Grid 2.54*2.54mm
 Recommended PCB Layout
 Top View

MECHANICAL DRAWING (CHASSIS MOUNT)

units: mm[inch]
 tolerance: $\pm 0.50[\pm 0.020]$
 wire range: 24~12 AWG
 tightening torque: max 0.4 N*m

PIN CONNECTIONS	
PIN	Function
1	AC (N)
2	AC (L)
3	-Vo
4	+Vo

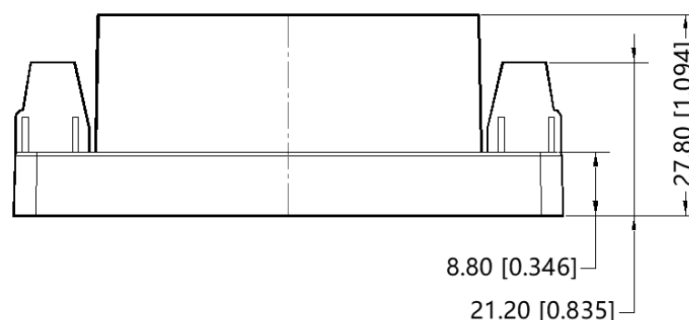
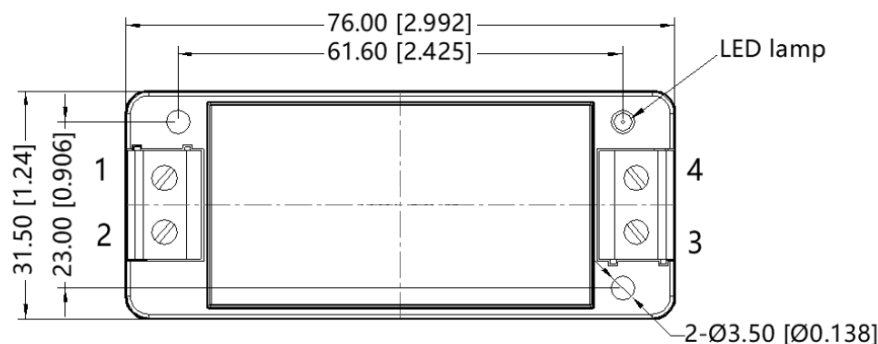

MECHANICAL DRAWING (DIN-RAIL MOUNT)

units: mm [inch]
tolerance: ± 0.050 [± 0.020]

installed on DIN Rail TS35
wire range: 24~12 AWG
tightening torque: max 0.4 N*m

PIN CONNECTIONS	
PIN	Function
1	AC (N)
2	AC (L)
3	-Vo
4	+Vo

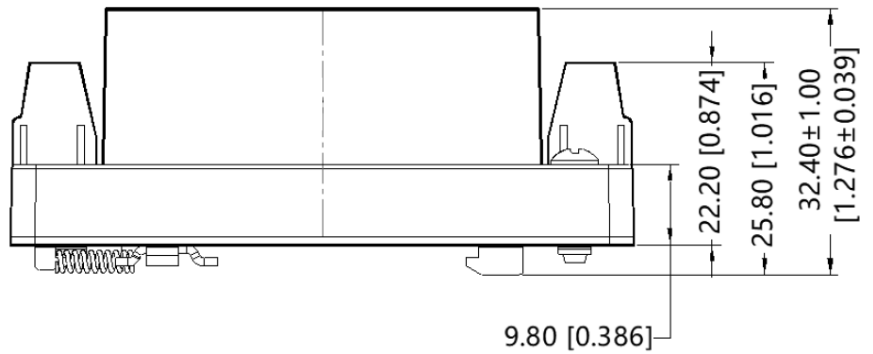
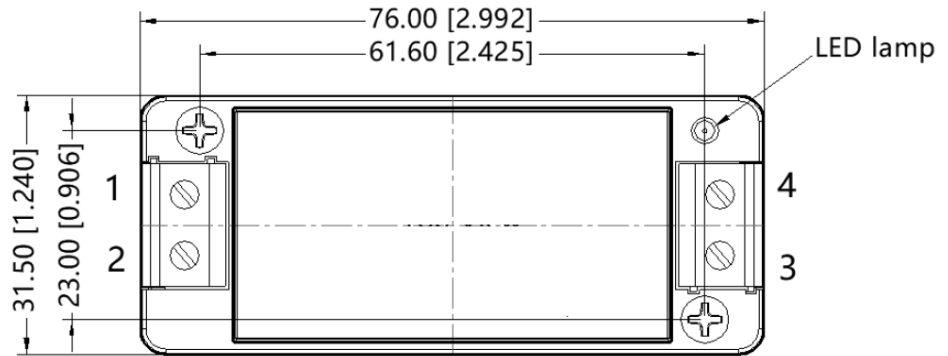

APPLICATION CIRCUIT

Figure 1

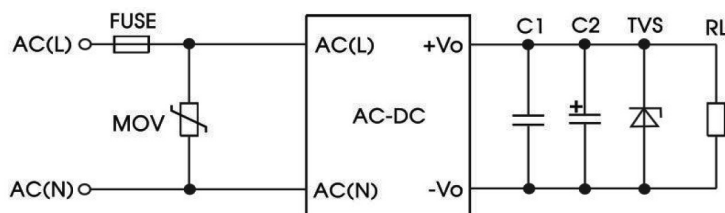

Table 1

Recommended External Circuit Components					
Vo (Vdc)	FUSE	MOV	C1	C2	TVS
3.3	2A/250V	S14K300	1 μ F/50 V	220 μ F/10V	SMBJ7.0A
5	2A/250V	S14K300	1 μ F/50 V	220 μ F/10V	SMBJ7.0A
9	2A/250V	S14K300	1 μ F/50 V	120 μ F/25V	SMBJ12A
12	2A/250V	S14K300	1 μ F/50 V	120 μ F/25V	SMBJ20A
15	2A/250V	S14K300	1 μ F/50 V	120 μ F/25V	SMBJ20A
24	2A/250V	S14K300	1 μ F/50 V	68 μ F/35V	SMBJ30A

EMC RECOMMENDED CIRCUIT

Figure 2

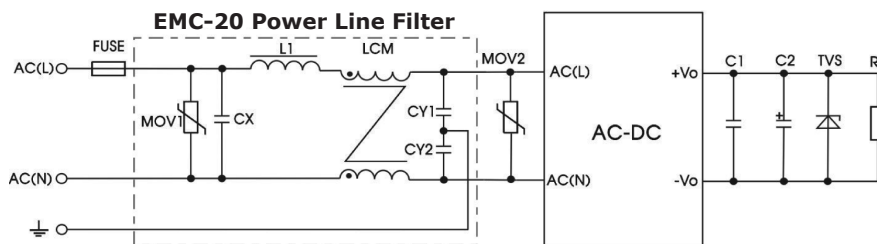

Table 2

Recommended External Circuit Components	
FUSE	3.15 A/250 V, slow fusing
MOV1	S14K350
LCM	10 mH
CX	0.1 μ F/275 Vac
CY1, CY2	1000 pF/400 Vac
L1	47 μ H/2 A
MOV2	S14K300

Note: Also refer to Table 1.

- Notes:
- C1 is a ceramic capacitor used to filter high frequency noise.
 - C2 is an electrolytic capacitor and it is recommended to be high frequency and low impedance. For capacitance and current of capacitor, refer to the datasheet provided by the manufacturer. Voltage derating of capacitor should be at least 80%.
 - TVS is a recommended component to protect post-circuits (if converter fails).

REVISION HISTORY

rev.	description	date
1.0	initial release	03/07/2019

The revision history provided is for informational purposes only and is believed to be accurate.



Headquarters
20050 SW 112th Ave.
Tualatin, OR 97062
800.275.4899

Fax 503.612.2383
cui.com
techsupport@cui.com

CUI offers a two (2) year limited warranty. Complete warranty information is listed on our website.

CUI reserves the right to make changes to the product at any time without notice. Information provided by CUI is believed to be accurate and reliable. However, no responsibility is assumed by CUI for its use, nor for any infringements of patents or other rights of third parties which may result from its use.

CUI products are not authorized or warranted for use as critical components in equipment that requires an extremely high level of reliability. A critical component is any component of a life support device or system whose failure to perform can be reasonably expected to cause the failure of the life support device or system, or to affect its safety or effectiveness.