

**CUI INC**

a bel group

date 04/05/2024

page 1 of 6

**SERIES:** P7805-S | **DESCRIPTION:** NON-ISOLATED SWITCHING REGULATOR**FEATURES**

- up to 500 mA current output
- operating temperature range (-40~85°C)
- pin comparable to LM78 linear regulators
- wider input range
- suited for negative output applications
- low ripple and noise
- efficiency up to 96%



MODEL	input voltage		output voltage (Vdc)	output current max (mA)	output power max (W)	ripple and noise <sup>1</sup> max (mVp-p)	efficiency typ (%)
	typ (Vdc)	range (Vdc)					
P7805-Q12-S1R5-S*	12	4.75~28	1.5	500	0.75	30	77
	12	4.75~25	-1.5	-400	0.6	35	66
P7805-Q12-S1R8-S*	12	4.75~28	1.8	500	0.90	30	81
	12	4.75~25	-1.8	-400	0.72	35	70
P7805-Q12-S2-S*	12	4.75~28	2.5	500	1.25	30	87
	12	4.75~25	-2.5	-400	1.0	35	73
P7805-Q24-S3-S*	24	4.75~28	3.3	500	1.65	30	91
	12	4.75~25	-3.3	-400	1.32	35	78
P7805-Q24-S5-S	24	6.5~32	5.0	500	2.5	30	94
	12	6.5~27	-5.0	-400	2	35	83
P7805-Q24-S6-S*	24	8~32	6.5	500	3.25	30	94
	12	6.5~25	-6.5	-300	1.95	35	84
P7805-Q24-S9-S*	24	11~32	9.0	500	4.5	30	95
	12	7.0~23	-9.0	-200	1.8	35	86
P7805-Q24-S12-S*	24	15~32	12	500	6.0	30	95
	12	7.0~20	-12	-200	2.4	35	87
P7805-Q24-S15-S*	24	18~32	15	500	7.5	30	96
	12	7~17	-15	-200	3.0	35	87

Notes: 1. Ripple and noise are measured at 20 MHz BW.  
2. \* Discontinued model

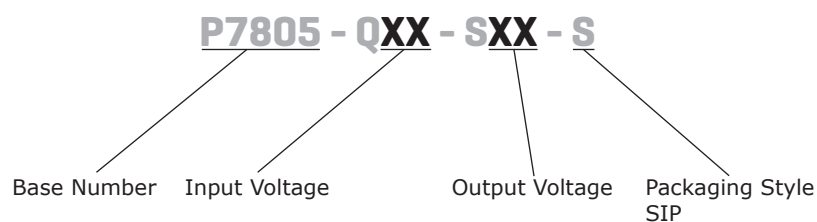
**PART NUMBER KEY**

## INPUT

parameter	conditions/description	min	typ	max	units
operating input voltage	-1.5, -1.8, -2.5, -3.3 V output	4.75	12	25	Vdc
	1.5, 1.8, 2.5, V output	4.75	12	28	Vdc
	3.3 V output	4.75	24	28	Vdc
	-5.0 V output	6.5	12	27	Vdc
	5.0 V output	6.5	24	32	Vdc
	-6.5 V output	6.5	12	25	Vdc
	6.5 V output	8	24	32	Vdc
	-9.0 V output	7	12	23	Vdc
	9.0 V output	11	24	32	Vdc
	-12 V output	7	12	20	Vdc
	12 V output	15	24	32	Vdc
	-15 V output	7	12	17	Vdc
	15 V output	18	24	32	Vdc
no-load input power	input voltage range		0.12	0.256	W
reverse polarity input	forbidden				
filter	capacitance filter (1 $\mu$ F)				

## OUTPUT

parameter	conditions/description	min	typ	max	units
capacitive load	for positive output applications			1,000	$\mu$ F
	for negative output applications			470	$\mu$ F
line regulation	input voltage range		$\pm 0.2$	$\pm 0.4$	%
load regulation	from 10% to 100% load		$\pm 0.4$	$\pm 0.6$	%
voltage accuracy	100% load, input voltage range		$\pm 2$	$\pm 3$	%
switching frequency	100% load, input voltage range	280	330	450	kHz
temperature coefficient	-40°C ~ 85°C			$\pm 0.02$	%/°C

## PROTECTIONS

parameter	conditions/description	min	typ	max	units
short circuit protection	continuous, automatic recovery				
short circuit input power	input voltage range		0.5	1.8	W
over temperature protection	internal IC junction			150	°C

## SAFETY AND COMPLIANCE

parameter	conditions/description	min	typ	max	units
conducted emissions	CISPR22/EN55022 class B (external circuit required, see figure 1-b)				
radiated emissions	CISPR22/EN55022 class B (external circuit required, see figure 1-b)				
ESD	IEC/EN 61000-4-2 class B, contact $\pm 4$ kV				
radiated immunity	IEC/EN 61000-4-3 class A, 10V/m				
EFT/burst	IEC/EN 61000-4-4 class B, $\pm 2$ kV (external circuit required, see figure 1-a)				
surge	IEC/EN 61000-4-5 class B, $\pm 2$ kV (external circuit required, see figure 1-a)				
conducted immunity	IEC/EN 61000-4-6 class A, 3 Vr.ms				
voltage dips & interruptions	IEC/EN 61000-4-29 class B, 0%-70%				
MTBF	as per MIL-HDBK-217F @ 25°C	2,000,000			hours
RoHS	2011/65/EU				

## ENVIRONMENTAL

parameter	conditions/description	min	typ	max	units
operating temperature	see derating curve	-40		85	°C
storage temperature		-55		125	°C
case temperature	operating temperature curve range			100	°C
storage humidity	non-condensing			95	%

## SOLDERABILITY

parameter	conditions/description	min	typ	max	units
hand soldering	1.5mm from case for 10 seconds			300	°C
wave soldering	see wave soldering profile			260	°C

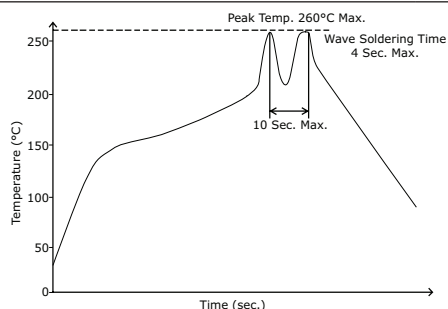

## MECHANICAL

parameter	conditions/description	min	typ	max	units
dimensions	11.60 x 7.50 x 10.20 (0.457 x 0.295 x 0.402 inch)				mm
case material	plastic (UL94-V0)				
weight			2.0		g

## MECHANICAL DRAWING

units: mm [inches]  
tolerance: ±0.25 [±0.010]  
pin section tolerance: ±0.10 mm [±0.004]

PIN CONNECTIONS		
Pin	Positive Output	Negative Output
1	+Vin	+Vin
2	GND	-Vout
3	+Vout	GND



Front View

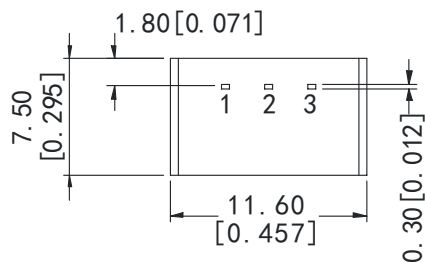

Bottom View

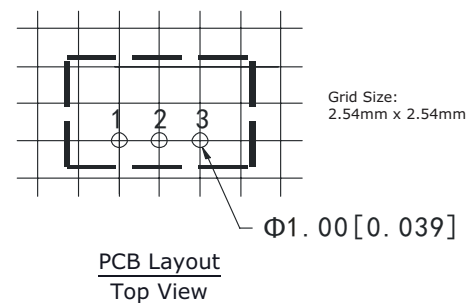

## DERATING CURVES

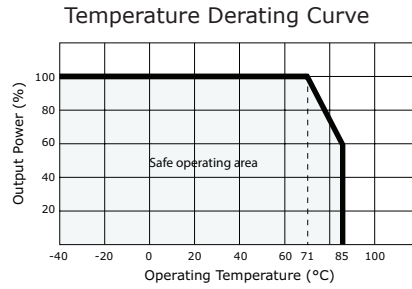

## EMC RECOMMENDED CIRCUIT

Figure 1



Recommended external circuit components	
FUSE	choose according to practical input current
MOV	S10K35
LDM1	82μH
LDM2	12μH
C0	680μF/50V
C3	4.7μF/50V

Note: See External Capacitor Table on page 5 for C1 & C2 values.

## TEST CONFIGURATION

Efficiency and Output Voltage Ripple Test



Start-up and Load Transient Response Test



## OUTPUT RIPPLE REDUCTION



Note: To reduce ripple, it is recommended to add a LC filter in output port. (L: Recommended parameter 10μH ~ 47 μH)

## TYPICAL APPLICATION CIRCUIT

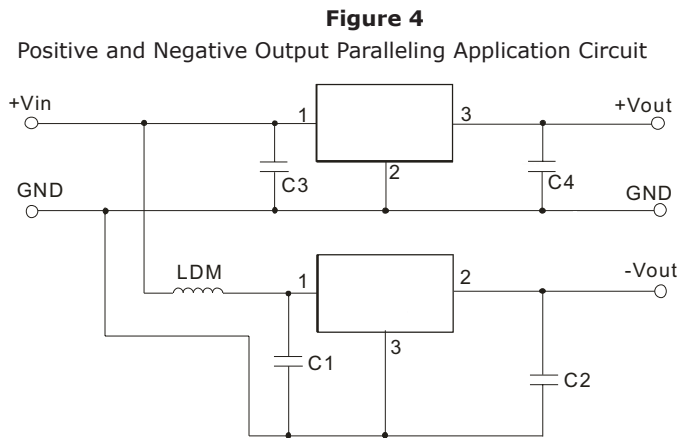
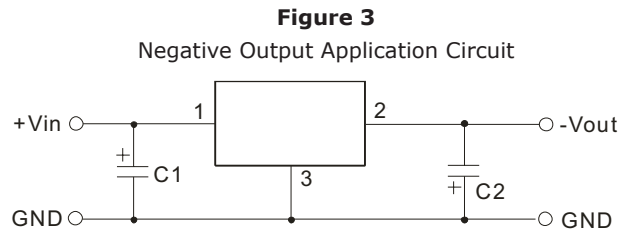
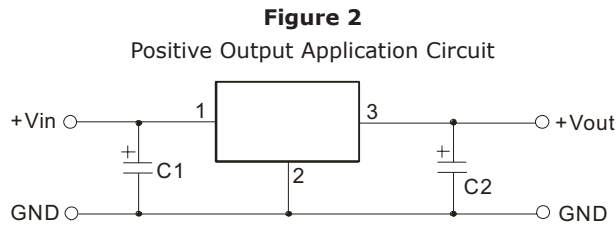

External Capacitor Table

Part Number	C1, C3 (ceramic capacitor)	C2, C4 (ceramic capacitor)
P7805-Q24-S1R5-S	10 $\mu$ F/50V	10 $\mu$ F/6.3V
P7805-Q24-S1R8-S	10 $\mu$ F/50V	10 $\mu$ F/6.3V
P7805-Q24-S2-S	10 $\mu$ F/50V	10 $\mu$ F/6.3V
P7805-Q24-S3-S	10 $\mu$ F/50V	10 $\mu$ F/6.3V
P7805-Q24-S5-S	10 $\mu$ F/50V	10 $\mu$ F/10V
P7805-Q24-S6-S	10 $\mu$ F/50V	10 $\mu$ F/16V
P7805-Q24-S9-S	10 $\mu$ F/50V	10 $\mu$ F/16V
P7805-Q24-S12-S	10 $\mu$ F/50V	10 $\mu$ F/25V
P7805-Q24-S15-S	10 $\mu$ F/50V	10 $\mu$ F/25V

- Note:
1. When the products used as negative output and the input-voltage under ( $V_{in-min}+2V$ ), C1 and C2 must be added in the circuit, and they should be placed as near as the products' footprints. Others apply to the application-environment.
  2. The capacitance of C1, C2, see external circuit table, can be increased if required, and tantalum or low ESR electrolytic capacitors may also suffice.
  3. When the products used as the circuit like figure 4, an inductor named as LDM up to 10 $\mu$ H is recommended in the circuit to reduce the mutual interference.
  4. For models  $\leq 3.3 V_{OUT}$ , if the input voltage of the model's negative output is less than 4.85 V, a dummy load of not less than 5 mA needs to be added to the output.
  5. Cannot use in parallel for output and hot swap for input.

- Note:
1. Max. capacitive load tested at input voltage range and full load.
  2. All specifications measured at:  $T_a=25^\circ\text{C}$ , humidity<75%, nominal input voltage and rated output load, unless otherwise specified.

## REVISION HISTORY

rev.	description	date
1.0	initial release	03/20/2013
1.01	updated EMC circuit recommendations	02/19/2015
1.02	company logo updated	04/14/2021
1.03	discontinued models P7805-Q24-S15-S, P7805-Q24-S3-S, P7805-Q24-S9-S	10/04/2023
1.14	discontinued models P7805-Q12-S1R5-S, P7805-Q12-S1R8-S, P7805-Q12-S2-S	01/12/2024
1.15	discontinued models P7805-Q24-S12-S & P7805-Q24-S6-S	04/05/2024

The revision history provided is for informational purposes only and is believed to be accurate.



**CUI INC**  
a bel group

**Headquarters**  
20050 SW 112th Ave.  
Tualatin, OR 97062  
**800.275.4899**

Fax 503.612.2383  
**cui.com**  
techsupport@cui.com

CUI offers a two (2) year limited warranty. Complete warranty information is listed on our website.

CUI reserves the right to make changes to the product at any time without notice. Information provided by CUI is believed to be accurate and reliable. However, no responsibility is assumed by CUI for its use, nor for any infringements of patents or other rights of third parties which may result from its use.

CUI products are not authorized or warranted for use as critical components in equipment that requires an extremely high level of reliability. A critical component is any component of a life support device or system whose failure to perform can be reasonably expected to cause the failure of the life support device or system, or to affect its safety or effectiveness.