

SERIES: SWI36-N | **DESCRIPTION:** AC-DC POWER SUPPLY

FEATURES

- up to 36 W continuous power
- DoE VI, ErP (Lot 7), GEMS, NRCAN, CEC, CoC Tier2 efficiency
- no load power consumption < 0.1 W
- universal input voltage range
- fixed North American AC blade
- over voltage, over current, and short circuit protections
- UL/cUL and PSE safety approvals
- certified to 62368-1 standards



MODEL	output voltage nom (Vdc)	output current max (A)	output power max (W)	ripple and noise ¹ max (mVp-p)	efficiency level
SWI36-5-N	5.0	5.00	25	80	VI
SWI36-7.5-N	7.5	4.00	30	75	VI
SWI36-8.5-N	8.5	3.52	30	85	VI
SWI36-9-N	9.0	3.34	30	90	VI
SWI36-12-N	12.0	3.00	36	120	VI
SWI36-13.5-N	13.5	2.66	36	135	VI
SWI36-15-N	15.0	2.40	36	150	VI
SWI36-16-N	16.0	2.25	36	160	VI
SWI36-18-N	18.0	2.00	36	180	VI
SWI36-24-N	24.0	1.50	36	240	VI
SWI36-48-N	48.0	0.75	36	480	VI

Notes: 1. At full load, nominal input, 20 MHz bandwidth oscilloscope, each output terminated with 0.1 µF multilayer and 47 µF low ESR electrolytic capacitors.

PART NUMBER KEY

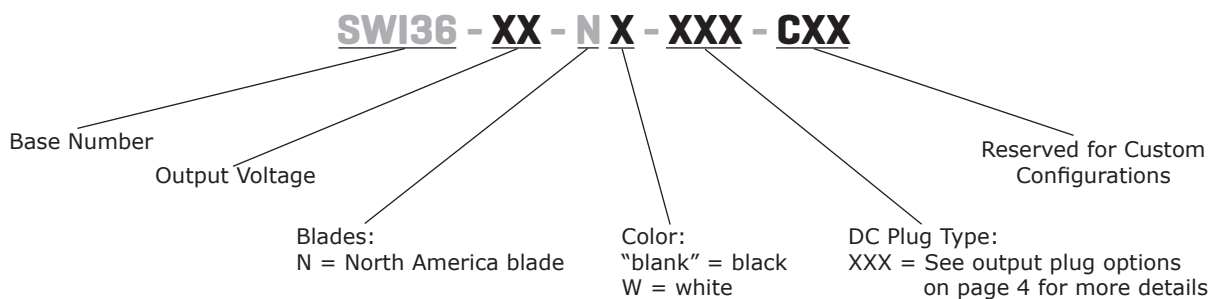

INPUT

parameter	conditions/description	min	typ	max	units
voltage		90	100~240	264	Vac
frequency		47	50~60	63	Hz
current				1	A
inrush current	at 230 Vac, full load, 25°C, cold start			70	A
leakage current				0.25	mA
no load power consumption	at 230 Vac			0.1	W

OUTPUT

parameter	conditions/description	min	typ	max	units
load regulation			±5		%

PROTECTIONS

parameter	conditions/description	min	typ	max	units
over voltage protection				180	%
over current protection				200	%
short circuit protection	auto recovery				

SAFETY & COMPLIANCE

parameter	conditions/description	min	typ	max	units
isolation voltage	input to output for 1 minute, 10 mA max		3,000		Vac
safety approvals	UL / CUL / PSE				
EMI/EMC	FCC (conduction & radiation Class B)				
MTBF	as per Telcordia SR-332, 25°C	300,000			hours
RoHS	yes				

ENVIRONMENTAL

parameter	conditions/description	min	typ	max	units
operating temperature	see derating curve	-20		40	°C
storage temperature		-20		80	°C
operating humidity	non-condensing	20		80	%
storage humidity	non-condensing	10		90	%

DERATING CURVE

TEMPERATURE DERATING CURVE

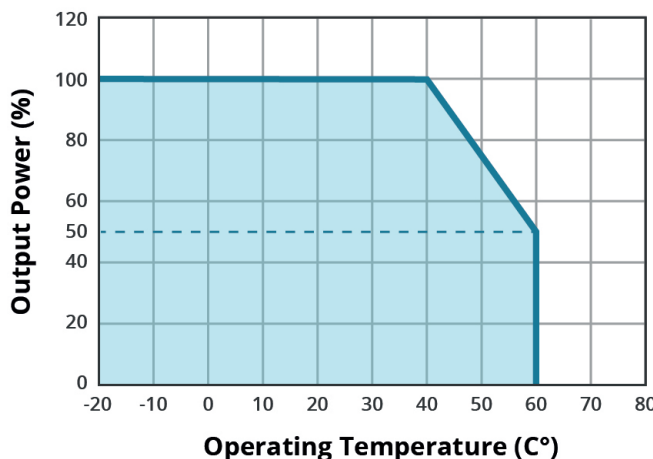

MECHANICAL

parameter	conditions/description	min	typ	max	units
dimensions	79 x 34 x 74				mm
inlet plug	fixed NA blade				
weight			160		g

MECHANICAL DRAWING

units: mm
tolerance: ±1.0 mm

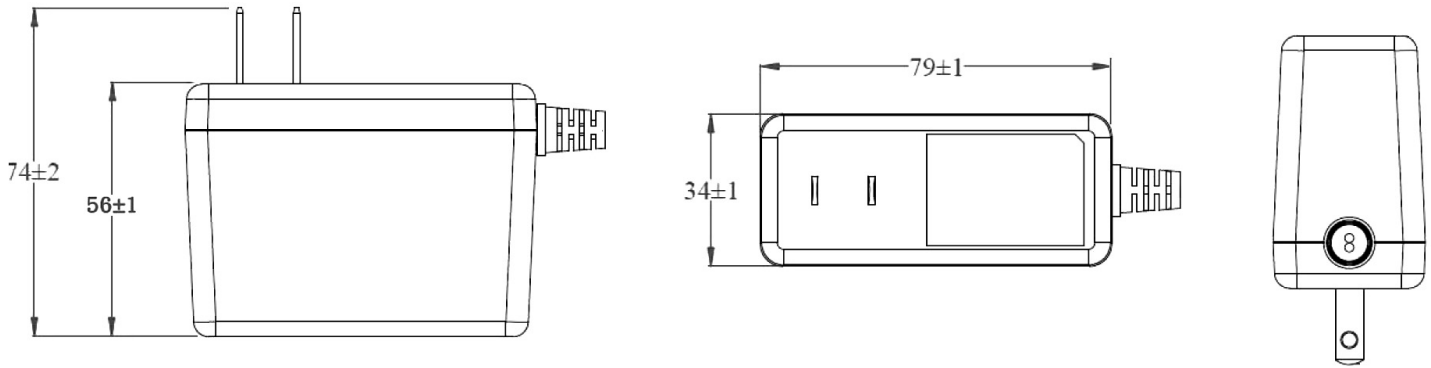

DC CORD

units: mm

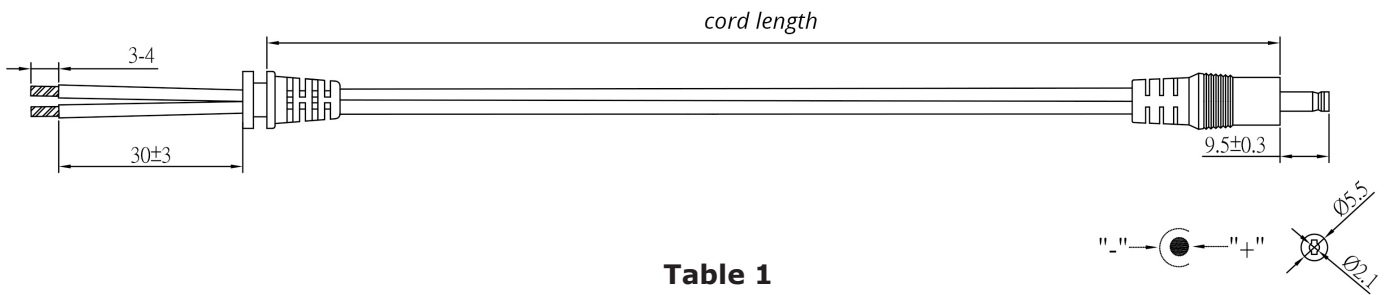

Table 1

MODEL NO.	CABLE	CORD LENGTH
SWI36-5-N	UL2468, 16 AWG	1,000 mm ±30
SWI36-7.5-N	UL2468, 16 AWG	1,500 mm ±30
SWI36-8.5-N	UL2468, 18 AWG	1,500 mm ±30
SWI36-9-N	UL2468, 18 AWG	1,500 mm ±30
SWI36-12-N	UL2468, 18 AWG	1,500 mm ±30
SWI36-13.5-N	UL2468, 18 AWG	1,500 mm ±30
SWI36-15-N	UL2468, 18 AWG	1,500 mm ±30
SWI36-16-N	UL2468, 18 AWG	1,500 mm ±30
SWI36-18-N	UL2468, 18 AWG	1,500 mm ±30
SWI36-24-N	UL2468, 20 AWG	1,500 mm ±30
SWI36-48-N	UL2468, 22 AWG	1,500 mm ±30

DC PLUG TYPE PART NUMBER KEY



Plug Polarity		Code		Dimensions (mm)			Plug Angle	
Center Pos.	Center Neg.	Option	Type	A	B	C	Straight	Right
•	•	5	Standard	5.5	2.1	9.5	•	•
•	•	6	Standard	5.5	2.5	9.5	•	•
•	•	7	Standard	3.5	1.35	9.5	•	•
•	•	8	Standard	3.8	1.35	9.5	•	•
•	•	9	Standard	3.8	1.05	9.5	•	•
•	•	10	Locking ²	5.5	2.1	9.5	•	N/A
•	•	11	Locking ²	5.5	2.5	9.5	•	N/A
•	•	12	EIAJ-1	2.35	0.7	9.5	•	•
•	•	13	EIAJ-2	4.0	1.7	9.5	•	•
•	•	14	EIAJ-3	4.75	1.7	9.5	•	•
N/A	N/A	ST	Stripped & Tinned			N/A	N/A	

Note: 1. Contact CUI for additional plug options
 2. Maximum insertion depth is 10mm

Standard

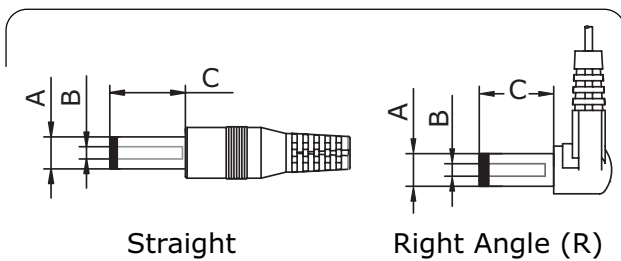

EIAJ

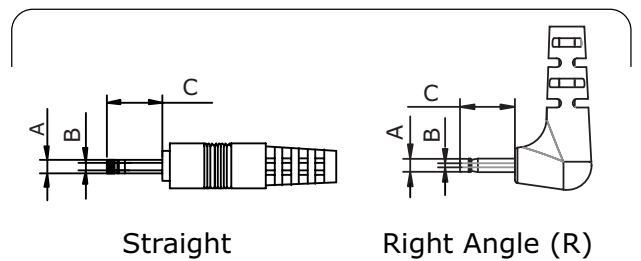

Locking

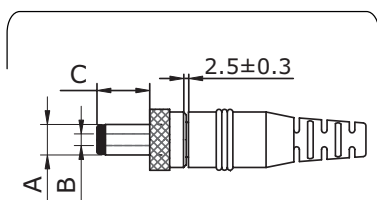

Stripped & Tinned

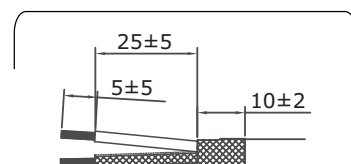

REVISION HISTORY

rev.	description	date
1.0	initial release	11/28/2023
1.01	datasheet updated	12/09/2024

The revision history provided is for informational purposes only and is believed to be accurate.



CUI INC

a bel group

Headquarters

15575 SW Sequoia Pkwy #100
Portland, OR 97224
800.275.4899

Fax 503.612.2383

cui.com

techsupport@cui.com

This device complies with part 15 of the FCC Rules. Operation is subject to the following two conditions:

- (1) This device may not cause harmful interference, and
- (2) this device must accept any interference received, including interference that may cause undesired operation.

CUI offers a one (1) year limited warranty. Complete warranty information is listed on our website.

CUI reserves the right to make changes to the product at any time without notice. Information provided by CUI is believed to be accurate and reliable. However, no responsibility is assumed by CUI for its use, nor for any infringements of patents or other rights of third parties which may result from its use.

CUI products are not authorized or warranted for use as critical components in equipment that requires an extremely high level of reliability. A critical component is any component of a life support device or system whose failure to perform can be reasonably expected to cause the failure of the life support device or system, or to affect its safety or effectiveness.