

SERIES: VOF-80B | **DESCRIPTION:** INTERNAL AC-DC POWER SUPPLY

FEATURES

- universal input range 90~264 Vac
- high efficiency up to 91%
- 2"x3" open frame compact size
- Class I and Class II
- operating altitude 5,000 m
- continuous short circuit protection
- certified to EN/BS EN/UL 62368-1
- designed to meet IEC/EN 60335-1, EN 55032

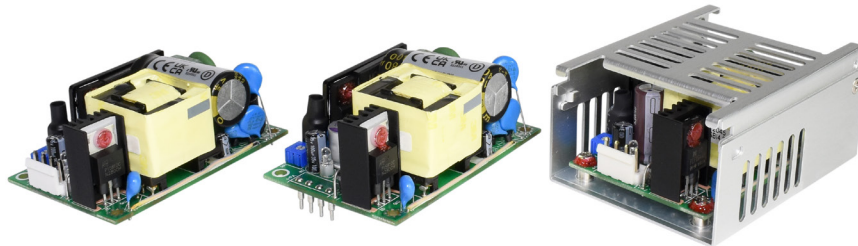

MODEL	output voltage		output current	output power	ripple and noise ¹	efficiency ²
	nom (Vdc)	range (Vdc)	max (A)	max (W)	max (mVp-p)	typ (%)
VOF-80B-12	12	11.4~12.6	6.7	80	120	89
VOF-80B-15	15	14.25~15.75	5.36	80	150	89
VOF-80B-24	24	22.8~25.2	3.35	80	240	90
VOF-80B-48	48	45.6~50.4	1.67	80	480	91

Notes: 1. At full load, nominal input, 20 MHz bandwidth oscilloscope, with 10 µF electrolytic and 0.1 µF ceramic capacitors on the output.
2. At 230 Vac input and 100% full load at 25°C.

PART NUMBER KEY

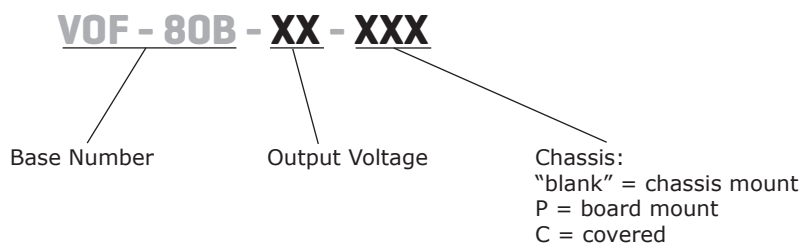

INPUT

parameter	conditions/description	min	typ	max	units
voltage ³	ac input	90		264	Vac
	dc input	120		370	Vdc
frequency		50		60	Hz
current	at 100 Vac, full load			1.7	A
inrush current	at 240 Vac, cold start at 25°C			100	A
leakage current				0.25	mA
no load power consumption	48 Vdc output		0.35		W
	all other output models		0.3		W

Note: 3. Safety approvals only apply to the ac input.

OUTPUT

parameter	conditions/description	min	typ	max	units
capacitive load	12 Vdc			13,400	μF
	15 Vdc			11,000	μF
	24 Vdc			6,700	μF
	48 Vdc			3,340	μF
output voltage set point	90 Vac ~ 264 Vac, full load, 25°C	11.88	12	12.12	Vdc
		14.85	15	15.15	Vdc
		23.76	24	24.24	Vdc
		47.52	48	48.48	Vdc
line regulation	90 Vac ~ 264 Vac, full load			±0.5	%
load regulation	10~100% load			±1	%
hold-up time	115 Vac		12		ms
switching frequency	output power = max. rated power		65		kHz

PROTECTIONS

parameter	conditions/description	min	typ	max	units
over voltage protection	built-in TVS component to clamp output voltage				
	12 Vdc			16.2	Vdc
	15 Vdc			18.9	Vdc
	24 Vdc			31.5	Vdc
	48 Vdc			58.8	Vdc
short circuit protection	continuous, auto recovery				

SAFETY & COMPLIANCE

parameter	conditions/description	min	typ	max	units
isolation voltage	input to output for 1 minute			3,000	Vac
safety approvals	certified to 62368-1: EN, BS EN, UL designed to meet 60335-1: IEC, EN designed to meet 55032: EN				
safety class	Class I or Class II				
conducted emissions	EN55032, EN61204-3:2000, EN61000-6-3:2012, EN61000-6-4:2011, Class B, 47 CFR FCC Part 15 Subpart B				
radiated emissions	EN55032, EN61204-3:2000, EN61000-6-3:2012, EN61000-6-4:2011, Class B, 47 CFR FCC Part 15 Subpart B				
ESD	IEC 61000-4-2:2008, air discharge: ±8kV, contact discharge: ±4kV, perf. Criteria A				
radiated immunity	IEC 61000-4-3:2010, perf. Criteria A				
EFT/burst	IEC61000-4-4:2012, ±1kV, ±2kV, perf. Criteria A				
surge	IEC61000-4-5:2014, L-N: ±0.5kV, ±1kV, L-E (Ground): ±0.5kV, ±1kV, ±2kV, perf. Criteria A				

SAFETY & COMPLIANCE

parameter	conditions/description	min	typ	max	units
conducted immunity	IEC 61000-4-6:2013, perf. Criteria A				
voltage dips and interruption	IEC 61000-4-11:2004, Dip: 30% reduction, dip >95% reduction, perf. Criteria A IEC 61000-4-11:2004, >95% reduction, perf. Criteria B				
power frequency magnetic field	IEC 61000-4-8:2009, perf. Criteria A				
vibration	meet MIL-STD-810F table 514.5CVIII,15~2000Hz, X,Y,Z axis, 1 hour (each axis). total 3 hrs		4		g
shock	meet MIL-STD-810F table 516.5, table 516.5-I 10ms, each axis 3 times ($\pm X, \pm Y, \pm Z$ axis)		75		g
MTBF	MIL-HDBK-217F at 25°C	300,000			hours
RoHS	yes				

ENVIRONMENTAL

parameter	conditions/description	min	typ	max	units
operating temperature	see derating curve	-30		80	°C
storage temperature		-30		85	°C
storage humidity	non-condensing			93	%
altitude				5,000	m

MECHANICAL

parameter	conditions/description	min	typ	max	units
dimensions	chassis mount: 76.20 x 50.80 x 34.00 [3.000 x 2.000 x 1.339 inch] board mount: 76.20 x 50.80 x 35.90 [3.000 x 2.000 x 1.413 inch] covered: 81.28 x 62.00 x 40.00 [3.200 x 2.441 x 1.575 inch]				mm mm mm
weight	chassis mount board mount covered		135 133 174		g g g

DERATING CURVE

PEAK LOAD V_{in} DE-RATING

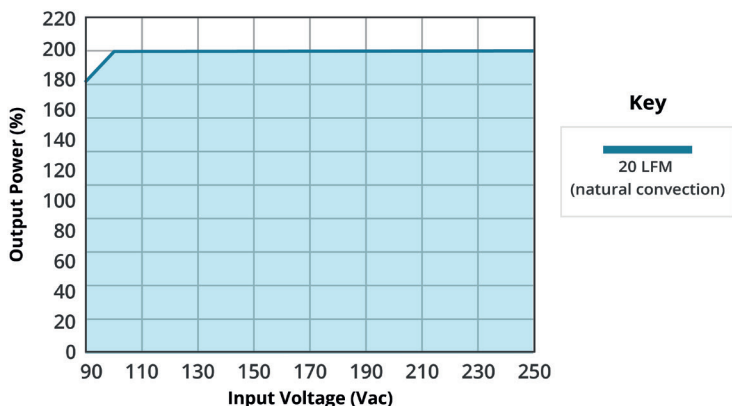

POWER DERATING CURVE (natural convection)

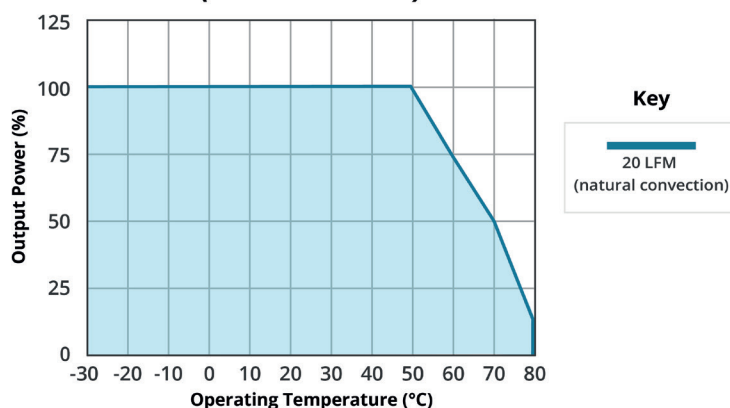

DERATING CURVE (CONTINUED)

POWER DERATING CURVE
(natural convection)

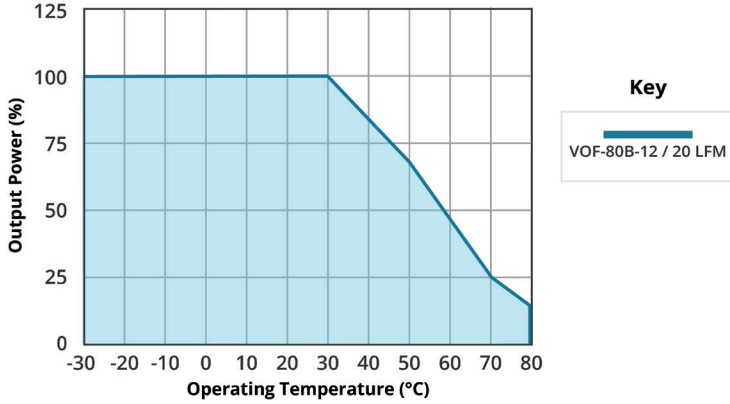

POWER DERATING CURVE
(natural convection)

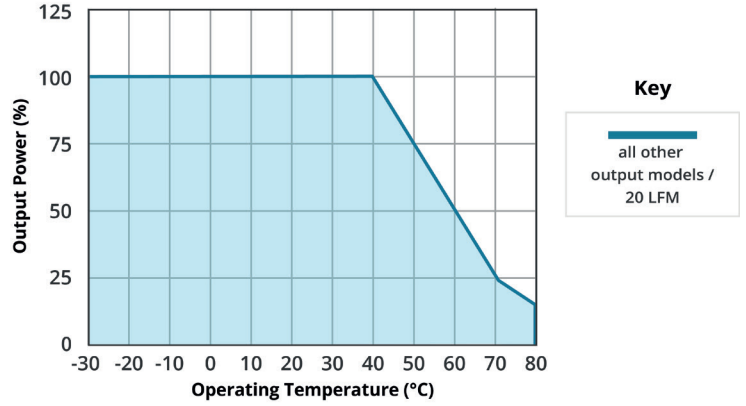

EFFICIENCY CURVES

EFFICIENCY VS INPUT LOAD
VOF-80B-12

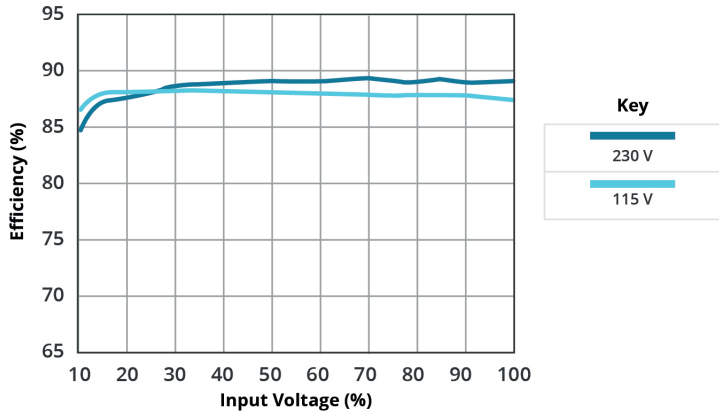

EFFICIENCY VS INPUT LOAD
VOF-80B-15

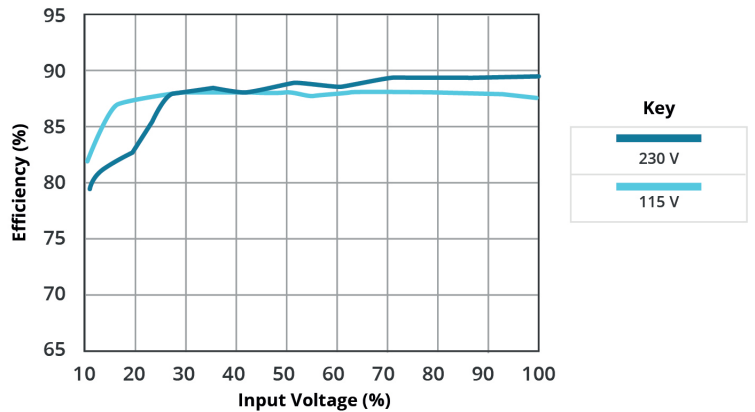

EFFICIENCY VS INPUT LOAD
VOF-80B-24

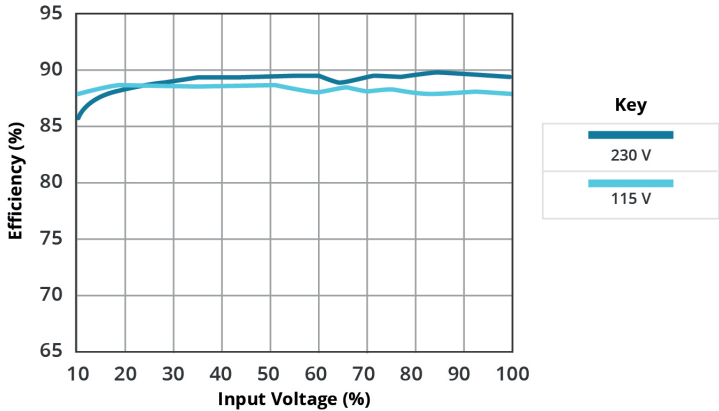

EFFICIENCY VS INPUT LOAD
VOF-80B-48

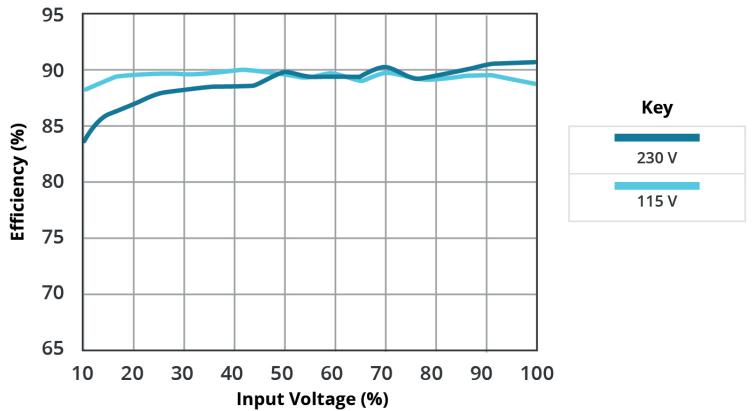

MECHANICAL DRAWING

Chassis mount

units: inches [mm]

tolerance inches: x.xxx = +0.039/-0

mm: x.xx = +1.0/-0

PIN CONNECTIONS	
PIN	Function
1	AC(N)
2	AC(L)

PIN CONNECTIONS	
PIN	Function
1	-Vout
2	-Vout
3	+Vout
4	+Vout

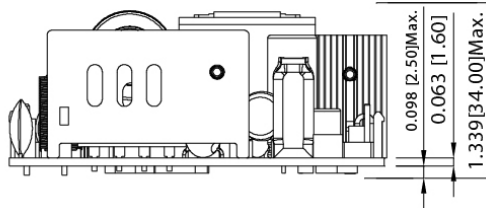
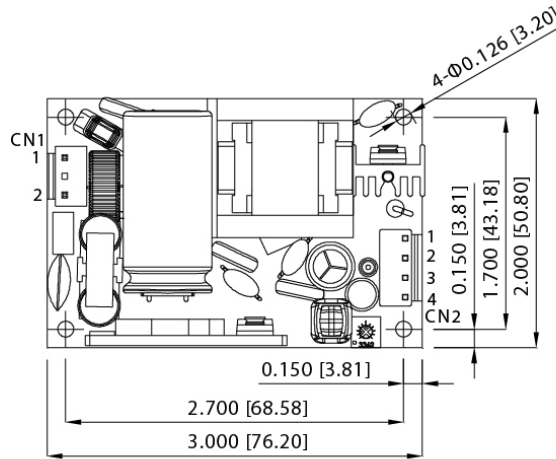

Board mount:

units: mm [inch]

units: inches [mm]

tolerance inches: x.xxx = +0.039/-0

mm: x.xx = +1.0/-0

PIN CONNECTIONS	
PIN	Function
1	AC(N)
2	AC(L)

PIN CONNECTIONS	
PIN	Function
1	-Vout
2	-Vout
3	+Vout
4	+Vout

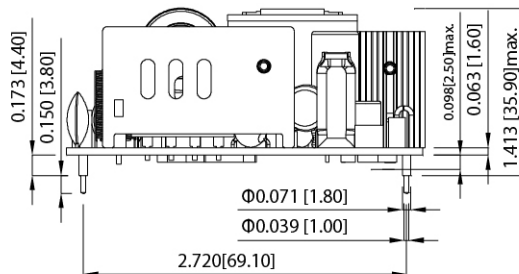
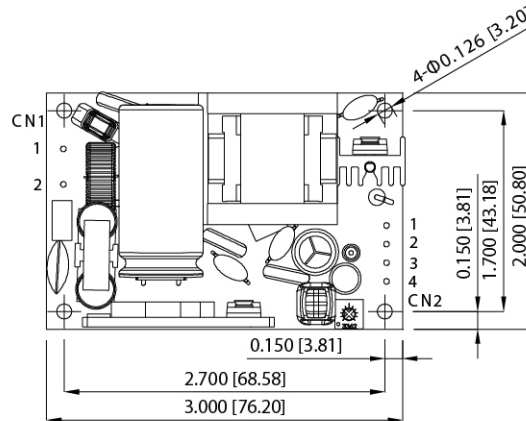

Covered:

units: mm [inch]

units: inches [mm]

tolerance inches: x.xxx = +0.039/-0

mm: x.xx = +1.0/-0

PIN CONNECTIONS	
PIN	Function
1	AC(N)
2	AC(L)

PIN CONNECTIONS	
PIN	Function
1	-Vout
2	-Vout
3	+Vout
4	+Vout

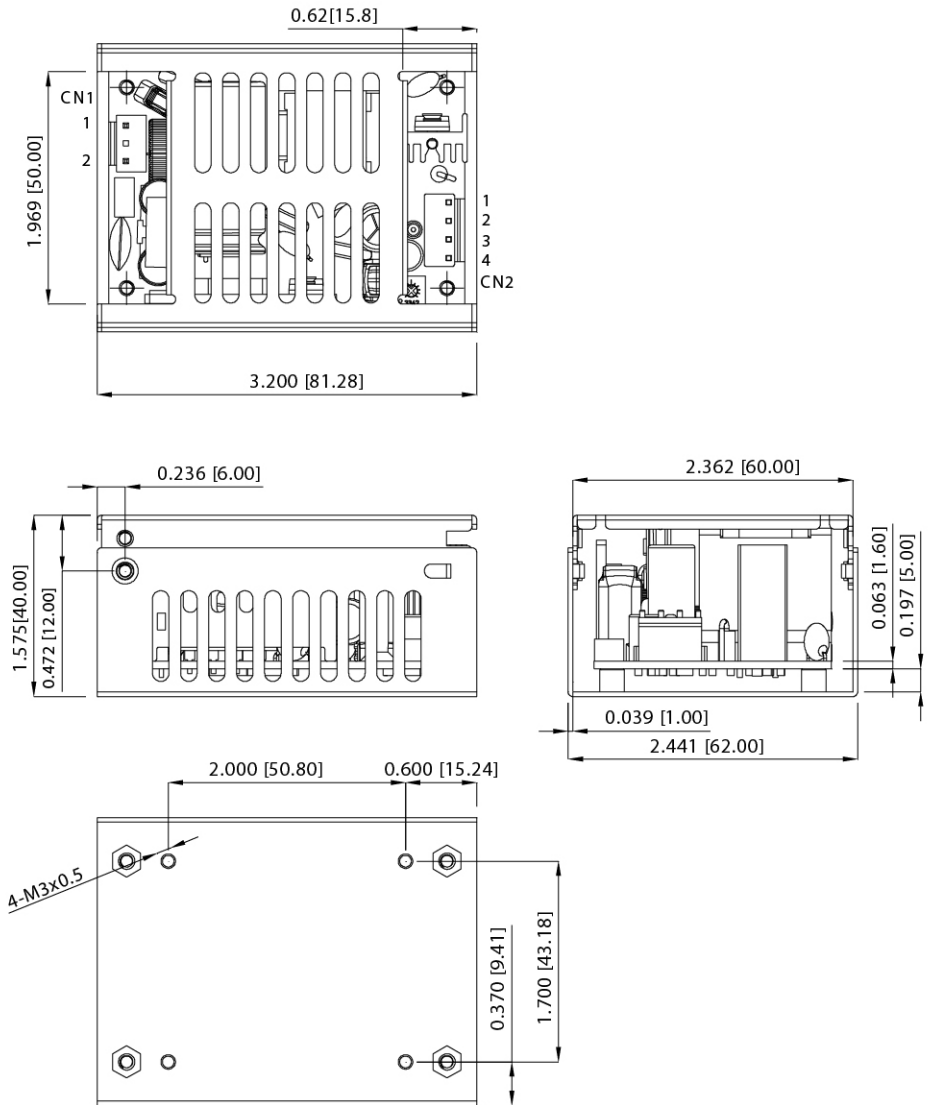

REVISION HISTORY

rev.	description	date
1.0	initial release	10/19/2023

The revision history provided is for informational purposes only and is believed to be accurate.



Headquarters
20050 SW 112th Ave.
Tualatin, OR 97062
800.275.4899

Fax 503.612.2383
cuicom
techsupport@cuicom

CUI offers a two (2) year limited warranty. Complete warranty information is listed on our website.

CUI reserves the right to make changes to the product at any time without notice. Information provided by CUI is believed to be accurate and reliable. However, no responsibility is assumed by CUI for its use, nor for any infringements of patents or other rights of third parties which may result from its use.

CUI products are not authorized or warranted for use as critical components in equipment that requires an extremely high level of reliability. A critical component is any component of a life support device or system whose failure to perform can be reasonably expected to cause the failure of the life support device or system, or to affect its safety or effectiveness.